



## REQUEST FOR BIDS (RFB)

**Name of the Procuring Entity:** Sri Lanka Air Force.

**Title of Contract:** Purchase of Medal with Ribbon for awarding the Commemorative Medal on the 75<sup>th</sup> Anniversary of the SLAF for S&MD stock

**Bid Number:** AHQ/25/FS/CLO/1004

1. This Request for Bids follows the General Procurement Notice/Advanced Procurement Notice for this purchase that appeared in:

a. Sunday Observer/ Daily News on 20 Apr 2025

2. The Chairman Department Procurement Committee (DPC) on behalf of the Sri Lanka Air Force now invites sealed bids/proposals from eligible and qualified bidders for Purchase of Medal with Ribbon for awarding the Commemorative Medal on the 75<sup>th</sup> Anniversary of the SLAF for S&MD stock

3. **The delivery period is.**

a. **Earliest Delivery Period:** 90 days

b. **Latest Delivery Period:** 120 days

4. Bidding will be conducted through International Competitive Bidding (ICB).

5. **Qualifications requirements include:**

a. Documents specified in eligibility and qualification requirements specified in Section V.

b. A margin of preference for eligible locally produced goods **shall be applied.**

6. **A complete set of Procurement Documents in English** may be purchased by interested bidders:

a. Upon submission of a written request to the address given in para 5 above.

b. Upon payment of a non-refundable fee of LKR 35,000.00 to the Director Finance of the Sri Lanka Air Force (SLAF) at the address given in para 5.

c. **Method of payment:** By cash.

7. Bids addressed to the Chairman Department Procurement Committee (DPC) must be delivered to the address mentioned in para 12.

- a. **Bids** should only be **hand delivered, sent via registered post or couriered.**
  - b. **Emailed bids** and bids sent via fax **will not be accepted.**
  - c. Late bids shall be rejected.
  - d. Bids/proposals will be opened at 1030 hrs on 03 June, 2025 in the presence of bidders' representatives (in-person or virtually) at LL2 Floor, Air Force Headquarters, Sri Jayewardenapura, Kotte.
8. All bids must include a **Bid-Security for the value of LKR 1,634,713.00 validity date until 18 October 2025.**
9. If stated in the Data Sheet the Bidder shall submit a certificate from the manufacturer to demonstrate that it has been duly authorized by the manufacturer or producer of the Goods to supply these Goods in Sri Lanka.
10. If the testing charges / samples are required by the Bidding Document (Please refer Section IV) the relevant conditions given in the Bidding Document shall be complied with in all respects without any reservation. The original cash receipt for testing charges issued by the Director Finance of the SLAF shall be attached to the original bid.
11. The successful bidder shall undertake to perform the resulting order/ contract with all-reasonable skill, diligence and care in accordance with sound industry practice to the satisfaction of the SLAF and accept full responsibility for the satisfactory quality of such goods/services as delivered /performed by them. Any non-conformity/ malfunction/ defect/ deficiency noticed in the goods delivered/ services rendered shall be promptly remedied by the successful bidder upon the receipt of written notice from the SLAF.
12. Interested eligible bidders may inspect the Procurement Documents at the address given above during 0900 hrs to 1500 hrs on any working day and obtain further information from

Chief Procurement Officer  
Air Force Headquarters  
P.O Box 594, Defence Headquarters Complex  
Sri Jayewardenepura, Kotte  
Sri Lanka  
**Tel:** +94 112 328850/ 2441553  
**E-mail:** [lquote@slaf.gov.lk](mailto:lquote@slaf.gov.lk)

*-Signed-*  
**(LADW LALINDA)**  
Group Captain  
Actg Chief Procurement Officer  
for **COMMANDER OF THE AIR FORCE**

21 April 2025

## SECTION I. INSTRUCTIONS TO BIDDERS (ITB)

ITB shall be read in conjunction with the Section II, Bidding Data Sheet (BDS), which shall take precedence over ITB.

SECTION	ITB	Clause
<b>GENERAL</b>	<b>1. Scope of Bid</b>	<p>1.1 The Purchaser indicated in the Bidding Data Sheet (BDS), issues these Bidding Documents for the supply of Goods and Related Services incidental thereto as specified in Section V, Schedule of Requirements. The name and identification number of this procurement are specified in the BDS. The name, identification, and number of lots (individual contracts), if any, are provided in the BDS.</p> <p>1.2 Throughout these Bidding Documents:</p> <p>(a) the term “in writing” means communicated in written form by mail (other than electronic mail) or hand delivered with proof of receipt;</p> <p>(b) if the context so requires, “singular” means “plural” and vice versa; and</p> <p>(c) “day” means calendar day.</p>
	<b>2. Source of Funds</b>	2.1 Payments under this contract will be financed by the source specified in the BDS.
	<b>3. Ethics, Fraud and Corruption</b>	<p>3.1 The attention of the bidders is drawn to the following guidelines of the Procurement Guidelines published by National Procurement Agency: - Parties associated with Procurement Actions, namely, suppliers/contractors and officials shall ensure that they maintain strict confidentiality throughout the process;</p> <p>- Officials shall refrain from receiving any personal gain from any Procurement Action. No gifts or inducement shall be accepted. Suppliers/contractors are liable to be disqualified from the bidding process if found offering any gift or inducement which may have an effect of influencing a decision or impairing the objectivity of an official.</p>

		<p>3.2 The Purchaser requires the bidders, suppliers, contractors, and consultants to observe the highest standard of ethics during the procurement and execution of such contracts. In pursuit of this policy:</p> <p>(a) “corrupt practice” means the offering, giving, receiving, or soliciting, directly or indirectly, of anything of value to influence the action of a public official in the procurement process or in contract execution;</p> <p>(b) “fraudulent practice” means a misrepresentation or omission of facts in order to influence a procurement process or the execution of a contract;</p> <p>(c) “collusive practice” means a scheme or arrangement between two or more bidders, with or without the knowledge of the Purchaser to establish bid prices at artificial, non-competitive levels; and</p> <p>(d) “coercive practice” means harming or threatening to harm, directly or indirectly, persons or their property to influence their participation in the procurement process or affect the execution of a contract.</p> <p>3.3 If the Purchaser found any unethical practices as stipulated under ITB Clause 3.2, the Purchaser will reject a bid, if it is found that a Bidder directly or through an agent, engaged in corrupt, fraudulent, collusive or coercive practices in competing for the Contract in question.</p>
<p><b>ELIGIBLE BIDDERS</b></p>	<p><b>4. Eligible Bidders</b></p>	<p>4.1 All bidders shall possess legal rights to supply the Goods under this contract. 4.2 A Bidder shall not have a conflict of interest. All bidders found to have conflict of interest shall be disqualified. Bidders may be considered to have a conflict of interest with one or more parties in this bidding process, if they:</p> <p>(a) are or have been associated in the past, with a firm or any of its affiliates which have been engaged by the Purchaser to provide consulting services for the preparation of the design, specifications, and other documents to be used</p>

		<p>for the procurement of the goods to be purchased under these Bidding Documents; or</p> <p>(b) submit more than one bid in this bidding process. However, this does not limit the participation of subcontractors in more than one bid.</p> <p>4.3 A Bidder that is under a declaration of ineligibility by the National Procurement Agency (NPA), at the date of submission of bids or at the date of contract award, shall be disqualified. The list of debarred firms is available at the website of NPA, <a href="http://www.npa.gov.lk">www.npa.gov.lk</a>.</p> <p>4.4 Foreign Bidder may submit a bid only if so stated in the BDS.</p>
<b>ELIGIBLE GOODS AND RELATED SERVICES</b>	<b>5. Eligible Goods and Related Services</b>	<p>5.1 All goods supplied under this contract shall be complied with applicable standards stipulated by the Sri Lanka Standards Institute (SLSI). In the absence of such standards, the Goods supplied shall be complied to other internationally accepted standards.</p>
<b>CONTENTS OF BIDDING DOCUMENTS</b>	<b>6. Sections of Bidding Documents</b>	<p>6.1 The Bidding Documents consist of 2 Volumes, which include all the sections indicated below, and should be read in conjunction with any addendum issued in accordance with ITB Clause 8.</p> <p><b>VOLUME 1</b>  Section I. Instructions to Bidders (ITB)  Section VI. Conditions of Contract (CC)  Section VIII. Contract Forms</p> <p><b>VOLUME 2</b>  Section II. Bidding Data Sheet (BDS)  Section III. Evaluation and Qualification Criteria  Section IV. Bidding Forms  Section V. Schedule of Requirements  Section VII. Contract Data  Invitation For Bid</p> <p>6.2 The Bidder is expected to examine all instructions, forms, terms, and specifications in the Bidding Documents. Failure to furnish all information or documentation required by the Bidding Documents may result in the rejection of the bid.</p>

<p><b>CLARIFICATION AND AMENDMENT</b></p>	<p><b>7. Clarification of Bidding Documents</b></p>	<p>7.1 A prospective Bidder requiring any clarification of the Bidding Documents including the restrictiveness of specifications shall contact the Purchaser in writing at the Purchaser’s address specified in the BDS. The Purchaser will respond in writing to any request for clarification, provided that such request is received no later than ten (10) days prior to the deadline for submission of bids. The Purchaser shall forward copies of its response to all those who have purchased the Bidding Documents, including a description of the inquiry but without identifying its source. Should the Purchaser deem it necessary to amend the Bidding Documents as a result of a clarification, it shall do so following the procedure under ITB Clause 8.</p>
	<p><b>8. Amendment of Bidding Documents</b></p>	<p>8.1 At any time prior to the deadline for submission of bids, the Purchaser may amend the Bidding Documents by issuing addendum.</p> <p>8.2 Any addendum issued shall be part of the Bidding Documents and shall be communicated in writing to all who have purchased the Bidding Documents.</p> <p>8.3 To give prospective Bidders reasonable time in which to take an addendum into account in preparing their bids, the Purchaser may, at its discretion, extend the deadline for the submission of bids, pursuant to ITB Sub-Clause 23.2.</p>
<p><b>PREPARATION OF BIDS</b></p>	<p><b>9. Cost of Bidding</b></p>	<p>9.1 The Bidder shall bear all costs associated with the preparation and submission of its bid, and the Purchaser shall not be responsible or liable for those costs, regardless of the conduct or outcome of the bidding process.</p>
	<p><b>10. Language of Bid</b></p>	<p>10.1 The Bid, as well as all correspondence and documents relating to the Bid (including supporting documents and printed literature) exchanged by the Bidder and the Purchaser, shall be written in English language.</p>
	<p><b>11. Documents Comprising the Bid</b></p>	<p>11.1 The Bid shall comprise the following:</p> <p>(a) Bid Submission Form and the applicable Price Schedules, in accordance with ITB Clauses 12, 14, and 15;</p> <p>(b) Bid Security or Bid-Securing Declaration, in accordance with ITB Clause 20;</p>

		<p>(c) documentary evidence in accordance with ITB Clauses 18 and 29, that the Goods and Related Services conform to the Bidding Documents;</p> <p>(d) documentary evidence in accordance with ITB Clause 18 establishing the Bidder's qualifications to perform the contract if its bid is accepted; and</p> <p>(e) any other document required in the BDS.</p>
<b>BID SUBMISSION</b>	<b>12. Bid Submission Form and Price Schedules</b>	12.1 The Bidder shall submit the Bid Submission Form using the form furnished in Section IV, Bidding Forms. This form must be completed without any alterations to its format, and no substitutes shall be accepted. All blank spaces shall be filled in with the information requested.
	<b>13. Alternative Bids</b>	13.1 Alternative bids shall not be considered.
	<b>14. Bid Prices and Discounts</b>	<p>14.1 The Bidder shall indicate on the Price Schedule the unit prices and total bid prices of the goods it proposes to supply under the Contract.</p> <p>14.2 Any discount offered against any single item in the price schedule shall be included in the unit price of the item. However, a Bidder wishes to offer discount as a lot the bidder may do so by indicating such amounts appropriately.</p> <p>14.3 If so indicated in ITB Sub-Clause 1.1, bids are being invited for individual contracts (lots) or for any combination of contracts (packages). Unless otherwise indicated in the BDS, prices quoted shall correspond to 100 % of the items specified for each lot and to 100% of the quantities specified for each item of a lot. Bidders wishing to offer any price reduction (discount) for the award of more than one Contract shall specify the applicable price reduction separately.</p> <p>14.4</p> <p>(i) Prices indicated on the Price Schedule shall include all duties and sales and other taxes already paid or payable by the Supplier:</p>

		<p>(a) on components and raw material used in the manufacture or assembly of goods quoted; or</p> <p>(b) on the previously imported goods of foreign origin.</p> <p>(ii) However, VAT shall not be included in the price but shall be indicated separately;</p> <p>(iii) the price for inland transportation, insurance and other related services to deliver the goods to their final destination;</p> <p>(iv) the price of other incidental services.</p> <p>14.5 The Prices quoted by the Bidder shall be fixed during the Bidder's performance of the Contract and not subject to variation on any account. A bid submitted with an adjustable price quotation will be treated as non-responsive and rejected, pursuant to ITB Clause 31.</p> <p>14.6 All lots, if any, and items must be listed and priced separately in the Price Schedules. If a Price Schedule shows items listed but not priced, their prices shall be assumed to be included in the prices of other items.</p>
	<b>15. Currencies of Bid</b>	15.1 Unless otherwise stated in Bidding Data Sheet, the Bidder shall quote in Sri Lankan Rupees and payment shall be payable only in Sri Lanka Rupees.
	<b>16. Documents Establishing the Eligibility of the Bidder</b>	16.1 To establish their eligibility in accordance with ITB Clause 4, Bidders shall complete the Bid Submission Form, included in Section IV, Bidding Forms.
	<b>17. Documents Establishing the Conformity of the Goods and Related Services</b>	<p>17.1 To establish the conformity of the Goods and Related Services to the Bidding Documents, the Bidder shall furnish as part of its Bid the documentary evidence that the Goods conform to the technical specifications and standards specified in Section V, Schedule of Requirements.</p> <p>17.2 The documentary evidence may be in the form of literature, drawings or data, and shall consist of a detailed item by item description (given in Section V, Technical Specifications) of the essential technical and performance</p>



		<p>characteristics of the Goods and Related Services, demonstrating substantial responsiveness of the Goods and Related Services to the technical specification, and if applicable, a statement of deviations and exceptions to the provisions of the Schedule of Requirements.</p>
	<p><b>18. Documents Establishing the Qualifications of the Bidder</b></p>	<p>18.1 The documentary evidence of the Bidder's qualifications to perform the contract if its bid is accepted shall establish to the Purchaser's satisfaction:</p> <p>(a) A Bidder that does not manufacture or produce the Goods it offers to supply shall submit the Manufacturer's Authorization using the form included in Section IV, Bidding Forms to demonstrate that it has been duly authorized by the manufacturer or producer of the Goods to supply these Goods;</p> <p>(b) that the Bidder meets each of the qualification criterion specified in Section III, Evaluation and Qualification Criteria.</p>
	<p><b>19. Period of Validity of Bids</b></p>	<p>19.1 Bids shall remain valid until the date specified in the BDS. A bid valid for a shorter date shall be rejected by the Purchaser as non-responsive.</p> <p>19.2 In exceptional circumstances, prior to the expiration of the bid validity date, the Purchaser may request bidders to extend the period of validity of their bids. The request and the responses shall be made in writing. If a Bid Security is requested in accordance with ITB Clause 20, it shall also be extended for a corresponding period. A Bidder may refuse the request without forfeiting its Bid Security. A Bidder granting the request shall not be required or permitted to modify its bid.</p>
<p><b>BID SECURITY</b></p>	<p><b>20. Bid Security</b></p>	<p>20.1 The Bidder shall furnish as part of its bid, a Bid Security or a Bid-Securing Declaration, as specified in the BDS.</p> <p>20.2 The Bid Security shall be in the amount specified in the BDS and denominated in Sri Lanka Rupees, and shall:</p>

		<p>(a) at the bidder's option, be in the form of either a bank draft, a letter of credit, or a bank guarantee from a banking institution;</p> <p>(b) be issued by a institution acceptable to Purchaser. The acceptable institutes are published in the NPA website, <a href="http://www.npa.gov.lk">www.npa.gov.lk</a>.</p> <p>(c) be substantially in accordance with the form included in Section IV, Bidding Forms;</p> <p>(d) be payable promptly upon written demand by the Purchaser in case the conditions listed in ITB Clause 20.5 are invoked;</p> <p>(e) be submitted in its original form; copies will not be accepted;</p> <p>(f) remain valid for the period specified in the BDS.</p> <p>20.3 Any bid not accompanied by a substantially responsive Bid Security or Bid Securing Declaration in accordance with ITB Sub-Clause 20.1 and 20.2, may be rejected by the Purchaser as non-responsive.</p> <p>20.4 The Bid Security of unsuccessful Bidders shall be returned as promptly as possible upon the successful Bidder's furnishing of the Performance Security pursuant to ITB Clause 43.</p> <p>20.5 The Bid Security may be forfeited or the Bid Securing Declaration executed:</p> <p>(a) if a Bidder withdraws its bid during the period of bid validity specified by the Bidder on the Bid Submission Form, except as provided in ITB Sub-Clause 19.2; or</p> <p>(b) if a Bidder does not agreeing to correction of arithmetical errors in pursuant to ITB Sub-Clause 30.3</p> <p>(c) if the successful Bidder fails to:</p> <p>(i) sign the Contract in accordance with ITB Clause 42;</p>
--	--	--

		(ii) furnish a Performance Security in accordance with ITB Clause 43.
	<b>21. Format and Signing of Bid</b>	<p>21.1 The Bidder shall prepare one original of the documents comprising the bid as described in ITB Clause 11 and clearly mark it as "ORIGINAL." In addition, the Bidder shall submit a copy of the bid and clearly mark it as "COPY." In the event of any discrepancy between the original and the copy, the original shall prevail.</p> <p>21.2 The original and the Copy of the bid shall be typed or written in indelible ink and shall be signed by a person duly authorized to sign on behalf of the Bidder.</p> <p>21.3 Any interlineations, erasures, or overwriting shall be valid only if they are signed or initialled by the person signing the Bid.</p>
<b>SUBMISSION AND OPENING OF BIDS</b>	<b>22. Submission, Sealing and Marking of Bids</b>	<p>22.1 Bidders may always submit their bids by mail or by hand. (a) Bidders submitting bids by mail or by hand, shall enclose the original and the copy of the Bid in separate sealed envelopes, duly marking the envelopes as "ORIGINAL" and "COPY." These envelopes containing the original and the copy shall then be enclosed in one single envelope.</p> <p>22.2 The inner and outer envelopes shall:</p> <p>(a) Bear the name and address of the Bidder;</p> <p>(b) be addressed to the Purchaser in accordance with ITB Sub-Clause 23.1;</p> <p>(c) bear the specific identification of this bidding process as indicated in the BDS; and</p> <p>(d) bear a warning not to open before the time and date for bid opening, in accordance with ITB Sub-Clause 26.1.</p> <p>If all envelopes are not sealed and marked as required, the Purchaser will assume no responsibility for the misplacement or premature opening of the bid.</p>
	<b>23. Deadline for Submission of Bids</b>	<p>23.1 Bids must be received by the Purchaser at the address and no later than the date and time specified in the BDS.</p> <p>23.2 The Purchaser may, at its discretion, extend the deadline for the submission of bids by amending the Bidding Documents in accordance with ITB Clause 8, in which case all rights and obligations of the Purchaser and</p>

		Bidders previously subject to the deadline shall thereafter be subject to the deadline as extended.
	<b>24. Late Bids</b>	24.1 The Purchaser shall not consider any bid that arrives after the deadline for submission of bids, in accordance with ITB Clause 23. Any bid received by the Purchaser after the deadline for submission of bids shall be declared late, rejected, and returned unopened to the Bidder.
	<b>25. Withdrawal, and Modification of Bids</b>	<p>25.1 A Bidder may withdraw, or modify its Bid after it has been submitted by sending a written notice in accordance with ITB Clause 22, duly signed by an authorized representative, and shall include a copy of the authorization in accordance with ITB Sub-Clause 21.2, (except that no copies of the withdrawal notice are required). The corresponding substitution or modification of the bid must accompany the respective written notice. All notices must be: (a) submitted in accordance with ITB Clauses 21 and 22 (except that withdrawal notices do not require copies), and in addition, the respective envelopes shall be clearly marked “WITHDRAWAL,” or “MODIFICATION;” and (b) received by the Purchaser prior to the deadline prescribed for submission of bids, in accordance with ITB Clause 23.</p> <p>25.2 Bids requested to be withdrawn in accordance with ITB Sub-Clause 25.1 shall be returned to the Bidders only upon notification of contract award to the successful bidder in accordance with sub clause 41.1.</p> <p>25.3 No bid may be withdrawn, substituted, or modified in the interval between the deadline for submission of bids and the expiration of the period of bid validity specified by the Bidder on the Bid Submission Form or any extension thereof.</p>
	<b>26. Bid Opening</b>	<p>26.1 The Purchaser shall conduct the bid opening in public at the address, date and time specified in the BDS.</p> <p>26.2 First, envelopes marked “WITHDRAWAL” shall be opened and read out and the envelope with the corresponding bid may be opened at the discretion of the Purchaser. No bid withdrawal shall be permitted unless the corresponding withdrawal notice contains a valid authorization to request</p>

		<p>the withdrawal and is read out at bid opening. Envelopes marked “MODIFICATION” shall be opened and read out with the corresponding Bid. No Bid modification shall be permitted unless the corresponding modification notice contains a valid authorization to request the modification and is read out at Bid opening. Only envelopes that are opened and read out at Bid opening shall be considered further.</p> <p>26.3 All other envelopes shall be opened one at a time, reading out: the name of the Bidder and whether there is a modification; the Bid Prices, including any discounts and alternative offers; the presence of a Bid Security or Bid-Securing Declaration, if required; and any other details as the Purchaser may consider appropriate. Only discounts and alternative offers read out at Bid opening shall be considered for evaluation. No Bid shall be rejected at Bid opening except for late bids, in accordance with ITB Sub-Clause 24.1.</p> <p>26.4 The Purchaser shall prepare a record of the Bid opening that shall include, as a minimum: the name of the Bidder and whether there is a withdrawal, or modification; the Bid Price, per lot if applicable, including any discounts, and the presence or absence of a Bid Security or Bid-Securing Declaration. The bids that were opened shall be rescaled in separate envelopes, promptly after the bid opening. The Bidders’ representatives who are present shall be requested to sign the attendance sheet. A copy of the record shall be distributed to all Bidders who submitted bids in time.</p>
<p><b>EVALUATION AND COMPARISON OF BIDS</b></p>	<p><b>27. Confidentiality</b></p>	<p>27.1 Information relating to the examination, evaluation, comparison, and post-qualification (if applicable) of bids, and recommendation of contract award, shall not be disclosed to bidders or any other persons not officially concerned with such process until publication of the Contract Award.</p> <p>27.2 Any effort by a Bidder to influence the Purchaser in the examination, evaluation, comparison, and post-qualification of the bids or contract award decisions may result in the rejection of its Bid.</p>

		<p>27.3 Notwithstanding ITB Sub-Clause 27.2, if any Bidder wishes to contact the Purchaser on any matter related to the bidding process, from the time of bid opening to the time of Contract Award, it should do so in writing.</p>
	<p><b>28. Clarification of Bids</b></p>	<p>28.1 To assist in the examination, evaluation, comparison and post-qualification of the bids, the Purchaser may, at its discretion, request any Bidder for a clarification of its Bid. Any clarification submitted by a Bidder in respect to its Bid and that is not in response to a request by the Purchaser shall not be considered for purpose of evaluation. The Purchaser's request for clarification and the response shall be in writing. No change in the prices or substance of the Bid shall be sought, offered, or permitted, except to confirm the correction of arithmetic errors discovered by the Purchaser in the Evaluation of the bids, in accordance with ITB Clause 30.</p>
	<p><b>29. Responsiveness of Bids</b></p>	<p>29.1 The Purchaser's determination of a bid's responsiveness is to be based on the contents of the bid itself.</p> <p>29.2 A substantially responsive Bid is one that conforms to all the terms, conditions, and specifications of the Bidding Documents without material deviation, reservation, or omission. A material deviation, reservation, or omission is one that:</p> <ul style="list-style-type: none"> <li>(a) affects in any substantial way the scope, quality, or performance of the Goods and Related Services specified in the Contract; or</li> <li>(b) limits in any substantial way, inconsistent with the Bidding Documents, the Purchaser's rights or the Bidder's obligations under the Contract; or</li> <li>(c) if rectified would unfairly affect the competitive position of other bidders presenting substantially responsive bids.</li> </ul> <p>29.3 If a bid is not substantially responsive to the Bidding Documents, it shall be rejected by the Purchaser and may not subsequently be made responsive by the Bidder by correction of the material deviation, reservation, or omission.</p>

	<p><b>30. Nonconformities, Errors, and Omissions</b></p>	<p>30.1 Provided that a Bid is substantially responsive, the Purchaser may waive any non-conformities or omissions in the Bid that do not constitute a material deviation.</p> <p>30.2 Provided that a bid is substantially responsive, the Purchaser may request that the Bidder submit the necessary information or documentation, within a reasonable period of time, to rectify nonmaterial nonconformities or omissions in the bid related to documentation requirements. Such omission shall not be related to any aspect of the price of the Bid. Failure of the Bidder to comply with the request may result in the rejection of its Bid.</p> <p>30.3 Provided that the Bid is substantially responsive, the Purchaser shall correct arithmetical errors on the following basis:</p> <p>(a) if there is a discrepancy between the unit price and the line item total that is obtained by multiplying the unit price by the quantity, the unit price shall prevail and the line item total shall be corrected, unless in the opinion of the Purchaser there is an obvious misplacement of the decimal point in the unit price, in which case the line item total as quoted shall govern and the unit price shall be corrected;</p> <p>(b) if there is an error in a total corresponding to the addition or subtraction of subtotals, the subtotals shall prevail and the total shall be corrected; and</p> <p>(c) if there is a discrepancy between words and figures, the amount in words shall prevail, unless the amount in figures is greater, in which case the amount in figures shall prevail.</p> <p>30.4 If the Bidder that submitted the lowest evaluated Bid does not accept the correction of errors, its Bid shall be disqualified and its Bid Security shall be forfeited or its Bid-Securing Declaration shall be executed.</p>
	<p><b>31. Preliminary Examination of Bids</b></p>	<p>31.1 The Purchaser shall examine the bids to confirm that all documents and technical documentation requested in ITB Clause 11 have been provided, and to determine the completeness of each document submitted.</p>

		<p>31.2 The Purchaser shall confirm that the following documents and information have been provided in the Bid. If any of these documents or information is missing, the Bid shall be rejected.</p> <p>(a) Bid Submission Form, in accordance with ITB Sub-Clause 12.1;  (b) Price Schedules, in accordance with ITB Sub-Clause 12;  (c) Bid Security or Bid Securing Declaration, in accordance with ITB Clause 20.</p>
	<b>32. Examination of Terms and Conditions; Technical Evaluation</b>	<p>32.1 The Purchaser shall examine the Bid to confirm that all terms and conditions specified in the CC and the Contract Data have been accepted by the Bidder without any material deviation or reservation.</p> <p>32.2 The Purchaser shall evaluate the technical aspects of the Bid submitted in accordance with ITB Clause 17, to confirm that all requirements specified in Section V, Schedule of Requirements of the Bidding Documents have been met without any material deviation or reservation.</p> <p>32.3 If, after the examination of the terms and conditions and the technical evaluation, the Purchaser determines that the Bid is not substantially responsive in accordance with ITB Clause 29, the Purchaser shall reject the Bid.</p>
	<b>33. Conversion to Single Currency</b>	<p>33.1 If the bidders are allowed to quote in foreign currencies in accordance with sub clause 15.1, for evaluation and comparison purposes, the Purchaser shall convert all bid prices expressed in foreign currencies in to Sri Lankan Rupees using the selling rates prevailed 28 days prior to closing of bids as published by the Central Bank of Sri Lanka. If this date falls on a public holiday the earliest working day prior to the date shall be applicable.</p>
	<b>34. Domestic Preference</b>	<p>34.1 Domestic preference shall be a factor in bid evaluation only if stated in the BDS. If domestic preference shall be a bid-evaluation factor, the methodology for calculating the margin of preference and the criteria for its application shall be as specified in Section III, Evaluation and Qualification Criteria.</p>



	<p><b>35. Evaluation of Bids</b></p>	<p>35.1 The Purchaser shall evaluate each bid that has been determined, up to this stage of the evaluation, to be substantially responsive.</p> <p>35.2 To evaluate a Bid, the Purchaser shall only use all the factors, methodologies and criteria defined in this ITB Clause 35.</p> <p>35.3 To evaluate a Bid, the Purchaser shall consider the following:</p> <ul style="list-style-type: none"> <li>(a) the Bid Price as quoted in accordance with clause 14;</li> <li>(b) price adjustment for correction of arithmetic errors in accordance with ITB Sub-Clause 30.3;</li> <li>(c) price adjustment due to discounts offered in accordance with ITB Sub-Clause 14.2; and 14.3</li> <li>(d) adjustments due to the application of the evaluation criteria specified in the BDS from amongst those set out in Section III, Evaluation and Qualification Criteria;</li> <li>(e) adjustments due to the application of a domestic preference, in accordance with ITB Clause 34 if applicable.</li> </ul> <p>35.4 The Purchaser’s evaluation of a bid may require the consideration of other factors, in addition to the factors used in ITB Sub-Clause</p> <p>35.3, if specified in BDS. These factors may be related to the characteristics, performance, and terms and conditions of purchase of the Goods and Related Services. The effect of the factors selected, if any, shall be expressed in monetary terms to facilitate comparison of bids.</p> <p>35.5 If so specified in the BDS, these Bidding Documents shall allow Bidders to quote for one or more lots, and shall allow the Purchaser to award one or multiple lots to more than one Bidder. The methodology of evaluation to determine the lowest-evaluated lot combinations, is specified in Section III, Evaluation and Qualification Criteria.</p>
	<p><b>36. Comparison of Bids</b></p>	<p>36.1 The Purchaser shall compare all substantially responsive bids to determine the lowest-evaluated bid, in accordance with ITB Clause 35.</p>

	<b>37. Post qualification of the Bidder</b>	<p>37.1 The Purchaser shall determine to its satisfaction whether the Bidder that is selected as having submitted the lowest evaluated and substantially responsive bid is qualified to perform the Contract satisfactorily.</p> <p>37.2 The determination shall be based upon an examination of the documentary evidence of the Bidder's qualifications submitted by the Bidder, pursuant to ITB Clause 18.</p> <p>37.3 An affirmative determination shall be a prerequisite for award of the Contract to the Bidder. A negative determination shall result in disqualification of the bid, in which event the Purchaser shall proceed to the next lowest evaluated bid to make a similar determination of that Bidder's capabilities to perform satisfactorily.</p>
<b>AWARD OF CONTRACT</b>	<b>38. Purchaser's Right to Accept Any Bid, and to Reject Any or All Bids</b>	38.1 The Purchaser reserves the right to accept or reject any bid, and to annul the bidding process and reject all bids at any time prior to contract award, without thereby incurring any liability to Bidders.
	<b>39. Award Criteria</b>	39.1 The Purchaser shall award the Contract to the Bidder whose offer has been determined to be the lowest evaluated bid and is substantially responsive to the Bidding Documents, provided further that the Bidder is determined to be qualified to perform the Contract satisfactorily.
	<b>40. Purchaser's Right to Vary Quantities at Time of Award</b>	40.1 At the time the Contract is awarded, the Purchaser reserves the right to increase or decrease the quantity of Goods and Related Services originally specified in Section V, Schedule of Requirements, provided this does not exceed twenty five percent (25%) or one unit whichever is higher and without any change in the unit prices or other terms and conditions of the bid and the Bidding Documents.
	<b>41. Notification of Award</b>	<p>41.1 The Standstill Period will be observed to provide sufficient time for Bidders to consider whether they should submit an appeal against the Purchaser's decision to award the contract. The Standstill Period shall apply to all competitive bidding processes, except in the following circumstances:</p> <p>(a) Only a single bid/proposal has been received in response to the bidding process.</p>

		<p>(b) The procurement is conducted through Direct Contracting, Request for Quotations (RFQ), or Shopping methods.</p> <p>(c) The procurement is made to address an emergency situation, as determined by the relevant Government Authorities.</p> <p>41.2 Any unsuccessful Bidder may request a debriefing from the Purchaser to obtain further clarification on the reasons for the decision. The request for debriefing must be submitted in writing to the Purchaser before the expiry of the third (3rd) working day of the Standstill Period. The Purchaser shall conclude the debriefing and provide the requested information to the Bidder before the expiry of the fifth (5th) working day of the Standstill Period. If any Bidder wishes to submit an appeal against the Purchaser’s decision to award the contract, such appeal must be submitted in writing to the Purchaser before the expiry of the Standstill Period 10 working days.</p> <p>(b) The appeal shall include the grounds for the appeal and any supporting evidence.</p> <p>(c) The Purchaser shall review the appeal and respond in accordance with the applicable laws, regulations, and procurement guidelines.</p> <p>41.3 After the Standstill Period or any appeals being resolved, prior to the expiration of the period of bid validity, the Purchaser shall notify the successful Bidder, in writing, that its Bid has been accepted.</p> <p>41.4 Until a formal Contract is prepared and executed, the notification of award shall constitute a binding Contract.</p> <p>41.5 Upon the successful Bidder’s furnishing of the signed Contract Form and performance security pursuant to ITB Clause 43, the Purchaser will promptly notify each unsuccessful Bidder and will discharge its bid security, pursuant to ITB Clause 20.4.</p>
	<p><b>42. Signing of Contract</b></p>	<p>42.1 Within Seven (7) days after notification, the Purchaser shall complete the Agreement, and inform the successful Bidder to sign it.</p>

		42.2 Within Seven (7) days of receipt of such information, the successful Bidder shall sign the Agreement.
	<b>43. Performance Security</b>	<p>43.1 Within fourteen (14) days of the receipt of notification of award from the Purchaser, the successful Bidder, if required, shall furnish the Performance Security in accordance with the CC, using for that purpose the Performance Security Form included in Section VIII Contract forms. The Employer shall promptly notify the name of the winning Bidder to each unsuccessful Bidder and discharge the Bid Securities of the unsuccessful bidders pursuant to ITB Sub-Clause 20.4.</p> <p>43.2 Failure of the successful Bidder to submit the above-mentioned Performance Security or sign the Contract shall constitute sufficient grounds for the annulment of the award and forfeiture of the Bid Security or execution of the Bid-Securing Declaration. In that event the Purchaser may award the Contract to the next lowest evaluated Bidder, whose offer is substantially responsive and is determined by the Purchaser to be qualified to perform the Contract satisfactorily.</p>

## SECTION II. BIDDING DATA SHEET

SECTION	CLAUSE	GENERAL
<b>GENERAL</b>	ITB 1.1	The Purchaser is Sri Lanka Air Force.
	ITB 1.1	<b>The name of the Contract is:</b> Purchase of Medal with Ribbon for awarding the Commemorative Medal on the 75 <sup>th</sup> Anniversary of the SLAF for S&MD stock. <b>Bid Identification Number: AHQ/25/FS/CLO/1004</b>
	ITB 2.1	The source of funding Government of Democratic Socialist Republic of Sri Lanka.
	ITB 3.2 (c)	Submit a <b>Non-Collusion Affidavit</b> (refer to in Section IV Form V) as part of their bid submission, affirming that they have not engaged in any collusive, corrupt, or fraudulent practices in connection with the procurement process.
	ITB 4.4	Foreign bidders are <b>ALLOWED</b> to participate in bidding.
<b>CONTENTS OF BIDDING DOCUMENTS</b>	ITB 7.1	For Clarification of bid purposes only, the Purchaser's address is: Chief Procurement Officer Air Force Headquarters P.O Box 594, Defence Headquarters Complex Sri Jayewardenepura, Kotte Sri Lanka <b>Tel:</b> +94 112 328850/ 2441553 <b>E-mail:</b> lquote@slaf.gov.lk
<b>PREPARATION OF BIDS</b>	ITB 11.1 (e)	The documents that should be included in your bid: <b>i. Forwarding/ covering letter duly signed by the Authorized person. The following documents must be firmly attached to this letter:</b> <b>a. The original cash receipt issued for the purchase of the Bidding Document, by the Director of Finance (DF), Sri Lanka Air Force (SLAF).</b> <b>b. The original payment receipt for testing charges, issued by the DF, SLAF (if applicable).</b> <b>ii. Bid Security if applicable (if applicable, shall be as per the form available in Section IV – Form III).</b> <b>iii. Bid Submission Form (shall be as per the form available in Section IV – Form I).</b> <b>iv. Non-Collusion Affidavit (refer to in Section IV Form V)</b> <b>v. Price Schedule (shall be as per the form available in Section IV – Form II)</b> <b>vi. A copy of the letter issued by Inland Revenue Department as an active VAT payee or Non- VAT payee.</b>

		<p>vii. <b>Company Profile</b> (shall be as per the form available in Section IV – Form VI).</p> <p>viii. <b>Authority of signing officer</b> (if applicable), whether a power of attorney or any relevant document (i.e., Letter of Authorization, Board Resolution) for the authorized person. In case of Joint Venture copy of JV Agreement or intent to form a Joint Venture.</p> <p>ix. <b>Documents required to establish ELIGIBILITY</b> as per Section V Schedule of Requirements.</p> <p>x. <b>Documents required to establish QUALIFICATION</b> as per Section V Schedule of Requirements.</p> <p>xi. <b>Duly prepared Certificate of Compliance</b> for the Schedule of Requirements given in Section V. This certificate shall evidence that the Goods/Services conform to the technical specifications, conditions and requirements and standards specified in Section V- Schedule of Requirements.</p> <p>xii. <b>Manufacturer’s Authorization</b> (shall be as per the form available in Section IV – Form IV)</p> <p>xiii. <b>Any other document specified in the ITB BDS.</b></p> <p>xiv. <b>A copy of this Bidding Document.</b></p> <p><i>Bidders are advised to compile the relevant documents as appropriate as per the sequence given in ITB C-1.</i></p>
	ITB 13	Alternative Bids will not be considered.
	ITB 14.3	Bidders are not allowed to quote less than 100% quantity for each item.
	ITB 15.1	<p>DDP (SLAF Base Katunayake – INCOTERMS 2020) price for the items/services to be delivered under this tender may be quoted in United States Dollars (USD), Sterling Pounds (£) or Euro. (The price should be inclusive of all related costs to deliver the goods to their final destination inclusive of duties, handling charges, sales and other taxes, transportation, insurance).</p> <p>The prices offered in Sri Lankan Rupees (LKR) shall also be for Delivery to SLAF Base Katunayake).</p> <p>Please note that the bids that will be based on foreign currency will be converted to the Sri Lankan Rupee by using the parity rate prevailed 28 days before the deadline for submission of bid.</p>
	ITB 17.1	a. <b>Technical Specifications / Brochures</b> for each product offered.
	ITB 17.2	a. <b>A statement of deviations and exceptions</b> to the provisions of the Technical Specifications given.

	ITB 18.1 (b)	After-sales service is: “not required”.
	ITB 19.1	The bid shall be valid until <b>01 October 2025</b> .
	ITB 20.1	Bid shall include a Bid Security (issued by bank) included in Section IV Bidding Forms.
	ITB 20.2	The amount of the Bid Security shall be LKR <b>1,634,713.00</b> The validity period of the bid security shall be until <b>28 October 2025</b> .
<b>SUBMISSION AND OPENING OF BIDS</b>	ITB 21.1	Bidders shall submit their bids in duplicate in sealed envelopes marked as ORIGINAL and DUPLICATE, containing all required documents, including all documents ITB 11.1 (BDS).
	ITB 22.2 (c)	The envelope must be clearly marked as "ORIGINAL" and DUPLICATE along with the Tender Details as follows and addressed to the Purchaser as specified in the Bidding Data Sheet (BDS). <b>Bid Number:</b> AHQ/25/FS/CLO/1004 <b>Title of Contract:</b> Error! Reference source not found. <b>Opening Date:</b> 03 June 2025. <b>Opening Time:</b> 1030 hrs.
	ITB 23.1	For bid submission purposes, the Purchaser’s address is:  Chief Procurement Officer Air Force Headquarters P.O Box 594, Defence Headquarters Complex Sri Jayewardenepura, Kotte Sri Lanka <b>Tel:</b> +94 112 328850/ 2441553 <b>E-mail:</b> lquote@slaf.gov.lk
	ITB 23.1	The deadline for the submission of bids is: <b>Date:</b> 03 June 2025. <b>Time:</b> 1030 hrs
	ITB 26.1	The bid opening shall take place at: Chief Procurement Officer Air Force Headquarters P.O Box 594, Defence Headquarters Complex Sri Jayewardenepura, Kotte Sri Lanka <b>Tel:</b> +94 112 328850/ 2441553 <b>E-mail:</b> lquote@slaf.gov.lk  <b>Date:</b> 03 June 2025. <b>Time:</b> 1030 hrs
<b>EVALUATION AND COMPARISON OF BIDS</b>	ITB 34.1	A margin of preference for eligible locally produced goods <b>shall be applied</b> .
	ITB 35.3(d)	The adjustments shall be determined using the following criteria, from amongst those set out in Section III, Evaluation and Qualification Criteria: (a) Deviation in Delivery schedule: +1% of bid price per week beyond the earliest delivery date.

		(b) Deviation in payment schedule: +Interest cost (AWPR+3%) for days below the 45-day standard. (These adjustments are comprehensively described in III).
	ITB 35.4	<p>The following factors will also be considered for evaluation in line with the criteria specified in Section III:</p> <ul style="list-style-type: none"> <li>a. Assessment of the quality standards of the goods or services offered. This will include certifications, compliance with industry standards, or past performance records.</li> <li>b. The length and terms of warranties offered, as well as the availability and quality of after-sales service and support.</li> <li>c. Compliance with the technical specifications outlined in the bidding documents. This will include performance characteristics, durability, and compatibility with existing systems.</li> <li>d. The track record and experience of the bidder in supplying similar goods or services. This will include references from previous clients or case studies of past projects.</li> <li>e. The financial health of the bidder, which may be assessed through financial statements, credit ratings, or other indicators of financial stability.</li> <li>f. Consideration of the environmental impact of the goods or services, including sustainability practices, eco-friendliness, and compliance with environmental regulations.</li> <li>g. Adherence to local laws and regulations, including labour laws, safety standards, and import/export regulations.</li> <li>h. The ability of the bidder to customize the goods or services to meet specific needs of the purchaser, as well as their flexibility in accommodating changes.</li> </ul>
	ITB 35.5	Refer to Section III Evaluation and Qualification Criteria, for the evaluation methodology.



### SECTION III

#### EVALUATION CRITERIA

1. The Sri Lanka Air Force (SLAF) reserves the right to evaluate and award a contract or contracts based on the following principles:

a. **Price Evaluation.** Bids will be evaluated based on the Total Amount, excluding VAT, contingencies, and provisional sums. The lowest bidder will be evaluated after adjusting for arithmetical errors, omissions, and other factors as specified in the Procurement Documents.

b. **Award Options.**

a. Evaluate total extended pricing for all items and award to a single bidder.

b. Evaluate total extended pricing by item, section, or category and award to multiple bidders.

c. Evaluate and make partial or no award of items.

2. **Clarifications.** To assist in the examination, evaluation, and comparison of bids, the Bid Evaluation Committee (BEC) may, at its discretion, request clarifications from bidders. However, no modifications to bid prices, delivery terms, or other key contractual conditions will be permitted.

3. **Preliminary Examination of Bids.** Before conducting a detailed evaluation, the Bid Evaluation Committee (BEC) will determine bid responsiveness based on the following criteria:

<b>Criteria</b>	<b>Yes</b>	<b>No</b>
The bid is complete and does not deviate from the scope.		
Bid bond/security has been furnished as per the requirements.		
Bid bond/security is submitted in the correct format.		
The bid security amount meets the specified percentage/requirement.		
The validity of the bid security matches the bid validity period.		
The bid remains valid for the duration specified in the bidding document.		
All other required forms, schedules, and annexures are included as provided in the Bidding Document.		
All pricing is firm, fixed, and valid for the contract duration.		
Clear Breakdown of costs is provided as required by the Bidding Document.		
Any computational errors have been corrected.		

All documents are properly signed by an authorized representative.		
Company stamp/seal is applied where necessary.		
Copies are certified/notarized if required.		
The completion period offered is within the specified limits.		
The bidder has fulfilled the eligibility and qualification requirements as per the bidding document.		
The bid does not deviate from basic technical requirements.		
The bid is generally in order.		

### Reasons for Bid Rejection

Reason	Yes	No
The bid is unsigned.		
The bid is delivered via fax/email.		
The bid is received after the deadline (late submission).		
The bid's validity period is shorter than required.		
The bid security is missing, invalid, or insufficient for validity required.		
The bidder refuses correction of arithmetical errors.		
Prices are conditional (e.g., linked to currency fluctuations or stock sales).		
All pricing is not firm, fixed, and valid for the contract duration.		
The bidder requests an advance payment.		
Mandatory pre-bid inspections have not been carried out (per bid conditions).		
Testing charges for samples (by a professional institution) are not deposited.		
Warranty terms (duration, coverage) do not meet requirements.		
Critical deviations from technical specifications or commercial terms.		
Price breakdown is insufficient for comprehensive evaluation as required by the Bidding Document.		
The bid lacks brochures, required certifications, technical details, or samples as required.		
The bidder fails to meet legal/financial/technical eligibility criteria.		
Eligibility or qualification requirements have not been met.		
The bid is submitted for an incomplete scope of work.		
The bid proposes a completion period beyond limits or deviates critically from the requirements.		

4. **Detailed Evaluation.** After passing the preliminary examination, bids will undergo a detailed evaluation based on the following criteria:

CRITERIA	JUDGMENT
<b>Technical Evaluation</b>	<ul style="list-style-type: none"> <li>- Compliance with required technical specifications including verification of proof of compliance with test reports/certificates</li> <li>- Scope of supply, delivery, or services.</li> <li>- Warranty, spare parts availability, and after-sales service requirements.</li> </ul>

	Products/services may undergo testing/certification as specified in Section V (inspection and tests) from professional local institutions such as <b>SLSI, SLITA, ITI, Moratuwa University</b> , etc.
<b>Commercial Evaluation</b>	- Terms of payment. - Delivery schedule or completion period. - Compliance with duties and taxes.
<b>Experience &amp; Past Performance</b>	- Experience in the respective field. - Experience in similar contracts.
<b>Financial</b>	Financial soundness of the bidder.
<b>Technical and managerial competence.</b>	<b>Technical Expertise and Project Management Strength</b> - Availability of <b>certified/qualified professionals</b> (engineers, technicians, specialists) - Proposed methodology and management plan. - Available resources (equipment & manpower). <b>Quality &amp; Compliance</b> - Technical certifications (ISO, industry-specific standards).
<b>Additional Considerations</b>	- Risk assessment. - Innovation & sustainability (if applicable).

5. **Price Evaluation & Adjustments.** Bids will be evaluated based on the Total Amount, excluding VAT, contingencies, and provisional sums. The lowest bidder will be determined after adjustments for the following factors:

- a. **Delivery Period.** Bids that proposes a delivery
- **Before the Earliest Delivery Date (Section VI, Delivery Schedule):** No credit given; delivery timeline treated as offered.
  - **After the Latest Delivery Date:** Non-responsive and rejected.
  - **Within the acceptable range (Earliest to Final Date, inclusive):** Eligible for evaluation.
- b. **Price Adjustment.** For bids offering delivery later than the Earliest Delivery Date, an adjustment of 1% of the bid price per additional week will be applied:

**Adjusted Price = Total Bid Price × [1 + (0.01 × (Offered Delivery Time – Earliest Delivery Time))]**

- c. **Credit Period.** A credit facility must be provided. The standard credit period required is 45 days, with a minimum acceptable credit period of 30 days. Bids offering credit terms below 45 days will be subject to an adjustment reflecting the financial cost of the variance, calculated based on the prevailing AWPR (weekly for LKR transactions) and SOFR (daily for Foreign Currency transactions) + 3% for administrative cost.

**Adjusted Bid Price = Total Bid Price × [1 + ((AWPR + 0.03) × (45 – Offered Credit Days) / 365)]**

**AWPR (Sri Lanka Average Weighted Prime Lending) for LKR**  
Rate): <https://www.cbsl.gov.lk/en/statistics/economic-indicators/daily-indicators>

**SOFR (Secured Overnight Financing Rate) for Foreign Currency**  
Contracts: <https://www.newyorkfed.org/markets/reference-rates/sofr>

d. **Domestic Preference:** +20% to foreign bids (if applicable).

6. **Award Options.** Depending on the evaluation, SLAF may opt for one of the following award methods:

- a. Award to a single bidder based on total extended pricing.
- b. Award by item, section, or category to multiple bidders.
- c. Partial or no award of certain items.

7. **Domestic Preference.** If applicable, domestic preference will be applied per PG 2024, Section 7.7.1. For comparison, an amount equal to **20% of the bid price** will be added to foreign (Group B) bids when compared with domestic (Group A) bids.

**Domestic Preference Criteria for Locally Manufactured Goods.** The domestic preference provision shall apply exclusively to manufactured goods, with bidders required to demonstrate compliance with all of the following conditions:

- a. **Local Content Requirement.** A minimum of thirty percent (30%) of the EXW (Ex-Works) price must comprise:
  - (1) Local labour costs
  - (2) Locally sourced raw materials
  - (3) Domestically produced components
- b. **Manufacturing Facility Qualification.** The production facility must:
  - (1) Be operational in Sri Lanka
  - (2) Have prior experience manufacturing the offered goods
  - (3) Demonstrate continuous manufacturing capability before the bid invitation date
- c. **Legal Registration**
  - (1) The bidder must be duly registered under the Companies Act No. 7 of 2007 (as amended)
- d. **Documentary Evidence Requirements.** Bidders must submit:
  - (1) A notarized affidavit certifying:  
Minimum 30% local value addition  
Detailed breakdown of the EXW price structure
  - (2) Certified audited financial statements:  
Substantiating the claimed 30% local value addition covering the most recent financial year.

- e. **Verification Process.** All claims of local content will be subject to:
  - (1) Independent verification by the Procuring Entity
  - (2) Potential audit by authorized government agencies
  
- f. **Any false declarations will result in:**
  - (1) Immediate disqualification
  - (2) Potential blacklisting proceedings

**Note:** Domestic preference will only be applied after full verification of all stipulated requirements, and bidders must facilitate the Bid Evaluation Committee's (BEC) verification process by providing access to manufacturing facilities for site visits and submitting all relevant supporting documents, including audited financial statements, procurement records, and payroll documentation. Bidders that fail to meet any of the domestic preference criteria will be reclassified as international suppliers and evaluated without price preference benefits. All verification findings will be formally documented and, upon request, shared with bidders to ensure transparency. Any false declarations or non-compliance will result in disqualification from the bidding process and may lead to further legal or administrative actions.

8. **Determination of the Lowest Evaluated Substantially Responsive Bid.** After applying all necessary adjustments (e.g., delivery period penalties, domestic preference adjustments, and credit period adjustments), the lowest evaluated substantially responsive bid will be selected.

9. **If alternative Bids allowed (Please refer BDS).** If the lowest evaluated substantially responsive and post-qualified bidder has submitted an alternative bid/offer, the alternative offer will be assessed using the same evaluation process and criteria applied to the original bid. This includes verification of technical details, compliance with bidding requirements (e.g., separate bid security, if applicable), and financial evaluation. The alternative offer will only be considered if its evaluated price is lower than the original bid's evaluated price.

**Important:** If alternative bids are allowed, the prospective Bidders are advised not to offer more than one alternative for the same item but furnish the most competitive among the options available to the bidder if so wishes. Alternative Bids / Offers made other than one will not be considered.

10. **Post-Qualification Checks.** Before awarding the contract, the selected lowest evaluated bidder will undergo a **final verification process** to confirm compliance with all financial, technical, and contractual requirements. The post-qualification verification will include:

- (1) **Financial Capacity Review:** Ensuring the bidder can meet financial obligations considering current work commitments.
- (2) **Performance Review:** Examination of past contract performance and compliance history including past SLAF experience with the bidder.
- (3) Verification that the bidder meets all necessary legal (litigation, sanctions – as per Form- VI of Section IV), and regulatory including Environmental compliance (if applicable).

(4) **Compliance with Contract Requirements:** Ensuring the bidder's agreement for the following contractual requirements as given in Section VI and Section VII.

S/No	Feature	Whether agreed by the firm	If deviates the reason
1.	Scope of Supply		
2.	Contract Price & Payment Terms		
3.	Quantity & Delivery		
4.	Transportation		
5.	Inspection & Tests		
6.	Rejection & Replacement		
7.	Warranty		
8.	Taxes & Duties		
9.	Signing of Contract		
10.	Performance Security		
11.	Liquidated Damages		
12.	Assumption of Compliance		
13.	Settlement of Disputes		
14.	Termination & Expiry of the Contract		
15.	Severability		
16.	Governing Law		
17.	Joint Venture		
18.	Force Majeure		
19.	Amendments		
20.	Confidentiality		

11. If the lowest evaluated bidder fails post-qualification, the next substantially responsive bid will be considered.

#### **PRICE EVALUATION CRITERIA FOR FOREIGN BIDDERS**

12. **Quotation Breakdown.** The price quoted as per price schedule given in **Form II (B)**, Section IV for foreign currency shall be evaluated.

13. **Currency Conversion for Evaluation.** All bid prices quoted in foreign currencies (USD, GBP, EUR) will be converted into Sri Lankan Rupees (LKR) for evaluation purposes. The conversion rate will be the selling rate published by the Central Bank of Sri Lanka, valid 28 days prior to the bid closing date. If the 28th day falls on a public holiday, the rate from the earliest working day prior to that date shall apply. Bidders must acknowledge and accept this currency conversion process as part of their submission.

14. **Evaluation of Total Cost.** Prospective local bidders shall quote in local currency on import and supply basis only. For bids submitted in foreign currency, evaluation will be based on the total Delivered Duty Paid (DDP) price (Incoterms® 2020) to SLAF Base Katunayake, Colombo, converted to LKR using the exchange rate specified in the bidding documents.

## Section IV.

### Bidding Forms Table of Forms

1. FORM I - Bid Submission Form
2. FORM II - Price Schedule
3. FORM III - Bid Security (Guarantee)
4. FORM IV - Manufacturer's Authorization
5. FORM V - Non-collusion Affidavit
6. FORM VI – Company Profile

## **FORM I - BID SUBMISSION FORM**

[Note: the purchaser is required to fill the information marked as “\*” and delete this note prior to selling of the bidding document]

[The Bidder shall fill in this Form in accordance with the instructions indicated No alterations to its format shall be permitted and no substitutions shall be accepted.]

**Date:** [insert date (as day, month and year) of Bid Submission]

**No.:** AHQ/25/FS/CLO/1004

**To: Commander of the Sri Lanka Air Force, Air Force Headquarters, P.O Box 594, Defence Headquarters Complex, Sri Jayewardenepura, Kotte, Sri Lanka**

We, the undersigned, declare that:

- (a) We have examined and have no reservations to the Bidding Documents, including Addenda No.: [insert the number and issuing date of each Addenda];
- (b) We offer to supply in conformity with the Bidding Documents and in accordance with the Delivery Schedules specified in the Schedule of Requirements the following Goods and Related Services Purchase of Medal with Ribbon for awarding the Commemorative Medal on the 75<sup>th</sup> Anniversary of the SLAF for S&MD stock;
- (c) The total price of our Bid without VAT, including any discounts offered is: [insert the total bid price in words and figures];
- (d) The total price of our Bid including VAT, and any discounts offered is: [insert the total bid price in words and figures];
- (e) Our bid shall be valid for the period of time specified in ITB Sub-Clause 19.1, from the date fixed for the bid submission deadline in accordance with ITB Sub-Clause 23.1, and it shall remain binding upon us and may be accepted at any time before the expiration of that period;
- (f) If our bid is accepted, we commit to obtain a performance security in accordance with ITB Clause 43 and CC Clause 17 for the due performance of the Contract;
- (g) We have no conflict of interest in accordance with ITB Sub-Clause 4.3;
- (h) Our firm, its affiliates or subsidiaries—including any subcontractors or suppliers for any part of the contract—has not been declared blacklisted by the National Procurement Commission;
- (k) We understand that this bid, together with your written acceptance thereof included in your notification of award, shall constitute a binding contract between us, until a formal contract is prepared and executed.



(1) We understand that you are not bound to accept the lowest evaluated bid or any other bid that you may receive.

Signed: [insert signature of person whose name and capacity are shown]

In the capacity of [insert legal capacity of person signing the Bid Submission Form]

Name: [insert complete name of person signing the Bid Submission Form]

Duly authorized to sign the bid for and on behalf of: [insert complete name of Bidder]

Dated on \_\_\_\_\_ day of \_\_\_\_\_, \_\_\_\_\_ [insert date of signing]

**FORM II (A) - PRICE SCHEDULE – SRI LANKAN RUPEES**

<b>Item No</b>	<b>Item Description</b>	<b>Den of Qty</b>	<b>Qty</b>	<b>Unit Price without VAT</b>	<b>VAT Rs</b>	<b>Total Price Rs</b>	<b>Brand Name</b>	<b>Country of Manufacture</b>	<b>Warranty</b>	<b>Sample Provided (YES) / Not Provided (NO)</b>	<b>Bidder's Remarks (Different Pack Size / Description , Part No, Model No, Colour, Item Discount % etc)</b>
1.	MEDAL WITH RIBBON SRI LANKA AIR FORCE 75TH ANNIVERSARY (STANDARD)	Ea	28,000								
2.	MEDAL WITH RIBBON SRI LANKA AIR FORCE 75TH ANNIVERSARY (MINIATURE)	Ea	14,000								
<b>Total Rs</b>											
<b>Discounts Rs</b>											
<b>Total Price after Discount Rs</b>											
<i>*The Prices shall be inclusive of Transport Charges including unloading at the given delivery location (i.e Supply &amp; Maintenance Depot SLAF Base Katunayake)</i>											

<b>VAT REGISTRATION LETTER (applicable for VAT payees)</b>	<b>YES / NO</b>	<b>VAT REGISTRATION NUMBER :</b>
<b>VAT EXCEPTION LETTER ATTACHED (applicable for non VAT payees)</b>	<b>YES / NO</b>	
<b>VAT LETTER AS AN ACTIVE VAT PAYEE ATTACHED</b>	<b>YES / NO</b>	
<b>VALIDITY OF BID</b>		
<b>VALUE OF BID SECURITY</b>		
<b>VALIDITY OF BID SECURITY</b>		
<b>BID SECURITY NO</b>		
<b>BID SECURITY OBTAINED FROM</b>		

**FORM II (B) - PRICE SCHEDULE – FOREIGN CURRENCY**

<b>Item No</b>	<b>Item Description</b>	<b>Den of Qty</b>	<b>Qty</b>	<b>Currency</b>	<b>Unit Price DDP</b>	<b>Line Total</b>	<b>Country of Manufacture</b>	<b>Warranty</b>	<b>Sample Provided (YES) / Not Provided (NO)</b>	<b>Bidder's Remarks (Different Pack Size / Description , Part No, Model No, Colour, Item Discount % etc)</b>
1.	MEDAL WITH RIBBON SRI LANKA AIR FORCE 75TH ANNIVERSARY (STANDARD)	Ea	28,000							
2.	MEDAL WITH RIBBON SRI LANKA AIR FORCE 75TH ANNIVERSARY (MINIATURE)	Ea	14,000							
<b>Total Rs</b>										
<b>Discounts Rs</b>										
<b>Total Price after Discount Rs</b>										
<i>*The Prices shall be inclusive of Transport Charges including unloading at the given delivery location (i.e Supply &amp; Maintenance Depot SLAF Base Katunayake)</i>										

<b>VAT REGISTRATION LETTER (applicable for VAT payees)</b>	<b>YES / NO</b>	<b>VAT REGISTRATION NUMBER :</b>
<b>VAT EXCEPTION LETTER ATTACHED (applicable for non VAT payees)</b>	<b>YES / NO</b>	
<b>VAT LETTER AS AN ACTIVE VAT PAYEE ATTACHED</b>	<b>YES / NO</b>	
<b>VALIDITY OF BID</b>		
<b>VALUE OF BID SECURITY</b>		
<b>VALIDITY OF BID SECURITY</b>		
<b>BID SECURITY NO</b>		
<b>BID SECURITY OBTAINED FROM</b>		

**IMPORTANT**

- \* Each page of the price schedule shall be authenticated by the bidder.
- \* The bidder shall ensure that all the details provided herein are 100% accurate.
- \* It is mandatory that the unit price of the article or service be inclusive of NBT Tax, if applicable. Based on that, VAT shall be indicated on the price which includes NBT.
- \* Manufacturing details of the goods and warranty details shall be provided in a separate list prepared by the bidder as applicable.

**ADDRESS AND CONTACT DETAILS OF THE BIDDER:**

**Name & Address:**

**Company Name:**

.....  
.....

**Registered Address.**

.....  
.....

**Contact Person  
Name.**

**Phone**

**Email**

1.....

.....

.....

2.....

.....

.....

**Date .....**

**Signature of Bidder .....**

## **FORM III - BID SECURITY (GUARANTEE)**

[This bank Guarantee form shall be filled in accordance with the instructions indicated in brackets]

----- [Insert issuing agency's name and address of issuing branch or office]

**Beneficiary: Commander of the Sri Lanka Air Force, Air Force Headquarters, P.O Box 594, Defence Headquarters Complex, Sri Jayewardenepura, Kotte, Sri Lanka**

Date: ----- [Insert (by issuing agency) date]

BID GUARANTEE No.: ----- [Insert (issuing agency) number]

We have been informed that ----- [Insert (issuing agency) name of the bidder; if a Joint Venture, list complete legal names of partners] (hereinafter called "the bidder") has submitted to you its bid dated ----- [Insert (issuing agency) date] (hereinafter called "the bid") for Purchase of Medal with Ribbon for awarding the Commemorative Medal on the 75<sup>th</sup> Anniversary of the SLAF for S&MD stock under invitation for bids No. **AHQ/25/FS/CLO/1004** ("the IFB").

Furthermore, we understand that, according to our conditions, Bids must be supported by a Bid Guarantee.

At the request of the Bidder, we ----- [Insert name of issuing agency] hereby irrevocably undertake to pay you any sum or sums not exceeding in total an amount of **LKR 1,634,713.00** [Insert amount in words] upon receipt by us of your first demand in writing accompanied by a written statement stating that the Bidder is in breach of its obligation(s) under the bid conditions, because the Bidder.

- (a) has withdrawn its Bid during the period of bid validity specified; or
- (b) does not accept the correction of errors in accordance with the instructions to Bidders (herein after "the ITB") of the IFB; or
- (c) having been notified of the acceptance of its Bid by the Employer/Purchaser during the period of bid validity,
  - (i) fails or refuses to execute the contract form, if required, or
  - (ii) fails or refuses to furnish the Performance Security, in accordance with the ITB. This Guarantee shall expire:

(a) if the Bidder is the successful bidder, upon our receipt of copies of the Contract signed by the Bidder and of the Performance Security issued to you by the Bidder; or

(b) if the Bidder is not the successful bidder, upon the earlier of

- (i) our receipt of a copy of your notification to the Bidder that the Bidder was unsuccessful, otherwise it will remain in force up to ----- (Insert date)

Consequently, any demand for payment under this Guarantee must be received by us at the office on or before that date -----.

[signature(s) authorized representative(s)]

**Notes:**

Bank Guarantees issued by any of the following Banks/Institutions are acceptable;

- (a) A local commercial bank approved by the Central Bank of Sri Lanka, which is operating in Sri Lanka;
- (b) A foreign commercial bank operating in Sri Lanka, which is approved by the Central Bank of Sri Lanka;
- (c) A foreign bank operating outside of Sri Lanka, provided that the relevant Bank Guarantee is confirmed by a local or foreign bank operating in Sri Lanka, which is approved by the Central Bank; and

Note: The requirement of confirmation referred to above is not necessary, if the entity that issues the guarantee is an Export Import Bank (EXIM Bank), Export Credit Agency of any foreign Government or a reputed international financier acceptable to the Central Bank of Sri Lanka if proof concerning such approval is available.



## **FORM IV - MANUFACTURER'S AUTHORIZATION**

[The Bidder shall require the Manufacturer to fill in this Form in accordance with the instructions indicated. This letter of authorization should be on the letterhead of the Manufacturer and should be signed by a person with the proper authority to sign documents that are binding on the Manufacturer. The Bidder shall include it in its bid, if so indicated in the BDS.]

Date: [insert date (as day, month and year) of Bid Submission]

No.: **AHQ/25/FS/CLO/1004**

To: **Commander of the Sri Lanka Air Force, Air Force Headquarters, P.O Box 594, Defence Headquarters Complex, Sri Jaywardenepura, Kotte, Sri Lanka**

WHEREAS

We [insert complete name of Manufacturer], who are official manufacturers of [insert type of goods manufactured], having factories at [insert full address of Manufacturer's factories], do hereby authorize [insert complete name of Bidder] to submit a bid the purpose of which is to provide the following Goods, manufactured by us [insert name and or brief description of the Goods], and to subsequently negotiate and sign the Contract.

We hereby extend our full guarantee and warranty in accordance with Clause 27 of the Conditions of Contract, with respect to the Goods offered by the above firm.

Signed: [insert signature(s) of authorized representative(s) of the Manufacturer]

Name: [insert complete name(s) of authorized representative(s) of the Manufacturer]

Title: [insert title]

Duly authorized to sign this Authorization on behalf of: [insert complete name of Bidder]

Dated on \_\_\_\_\_ day of \_\_\_\_\_, \_\_\_\_\_ [insert date of signing]

**FORM V - NON-COLLUSION AFFIDAVIT (TEMPLATE)**

The undersigned bidder or agent, hereby solemnly, sincerely, and truly declares and affirms/makes an oath and states as follows;

- a) That he/she has not, nor has any other member, representative, or agent of the firm, company, corporation, or partnership representing him/her, entered into any combination, collusion, or similar agreement with any person in connection with the price to be bid;
- b) That he/she or anyone representing him/her has not taken any step whatsoever to prevent any person from bidding, nor to induce anyone to refrain from bidding; and
- c) That this bid is made without reference to any other bid and without any agreement, understanding, or combination with any other person in reference to this bid.

He/she further states that no person, firm, or corporation has received or will receive, directly or indirectly, any rebate, fee, gift, commission, or thing of value in connection with the submission of this bid.

The bidder accepts full responsibility for ensuring the absence of collusion and hereby pledges to abide by fair and ethical competition practices throughout the procurement process and fully comply with the applicable Procurement Guidelines.

I hereby affirm, under the penalties for perjury, that all statements made by me in this affidavit are true and correct.

The foregoing Affidavit having been duly read over and explained by me to the Affirmant above named and he/she having understood the contents therein and admitted to be correct, affirmed and set his/her signature hereto before me) on this .... day of ... at ...

BEFORE ME,

JUSTICE OF THE PEACE/COMMISSIONER OF OATHS

## FORM VI - COMPANY DETAILS

<b>1.</b>	<b>COMPANY DETAILS</b>	
	<b>Name of the Company</b>	
	<b>Address</b>	
	<b>PV Number/ Company Registration Number</b>	
	<b>Date of Registration:</b>	
<b>2.</b>	<b>VAT</b>	
	VAT Registration Number	
<b>3.</b>	<b>POINT OF CONTACT</b>	
	<b>Contact name for enquiries about this submission:</b>	
	<b>Contact position (Job Title)</b>	
	<b>Address:</b>	
	<b>Tel number:</b>	
	<b>Fax number:</b>	
	<b>E-mail address:</b>	
<b>4.</b>	<b>OTHER DETAILS</b>	
<b>Does any of the following apply to your organisation, or to (any of) the director(s) / partners / proprietor (s)?</b>		
<b>Is in a state of bankruptcy, insolvency, compulsory winding up, receivership or subject to relevant proceedings:</b>		
<b>Has been convicted of a criminal offence related to business or professional conduct.</b>		
<b>Has committed an act of grave misconduct in the course of business</b>		
<b>Has not fulfilled obligations related to payment of social security contributions</b>		
<b>Has not fulfilled obligations related to payment of taxes</b>		
<b>Is guilty of serious misrepresentation in supplying information</b>		
<b>Is not in possession of relevant licences or membership of an appropriate organisation where required by law</b>		
<b>Whether from a country sanction under UN?</b>		
<b>If the answer to any of these is "Yes" please give brief details, including what has been done to put things right.</b>		

# **Section V.**

## **Schedule of Requirements**

### **Contents**

1. Delivery Schedule
2. Eligibility and Qualification Requirements
3. Technical Specifications
4. Drawings
5. Inspections and Tests

## 1. DELIVERY SCHEDULE

Earliest Delivery Period	Latest Delivery Period	Bidders offered Delivery Date	
90 days	120 days		
<b>Delivery Destination:</b>	Supply and Maintenance Depot, Sri Lanka Air Force Base Katunayake	<b>Agreed</b>	<b>Not Agreed</b>

The Bidder must indicate whether he **agreed** to deliver the goods / services to **the designated location of the SLAF** within the maximum allowable period. In other words, *deliveries beyond the latest delivery period will be rejected.*

### Instructions:

1. Cross out (✗) **either** "Agreed" **or** "Not Agreed" to confirm compliance.
2. Fill in the proposed delivery date within the range above.

### DETAILED EXPLANATION OF DELIVERY PERIOD CLAUSE

#### Key Definitions

#### 1. Latest Delivery Period.

- a. Absolute deadline set by the SLAF for delivery/completion.
- b. Bids exceeding this period **automatically rejected**.

#### 2. Earliest Acceptable Delivery Period.

- a. SLAF's preferred timeline for delivery/completion.
- b. Bids meeting this date gain a competitive advantage.

#### 3. Compliance Rules.

- a. **Non-negotiable rejection.** Proposals exceeding the maximum allowable period (Latest Delivery Period) will be disqualified.
- b. **Adjustment for delays beyond earliest date.** A **1% cost will be added** to the total bid price **per additional week** beyond the earliest delivery period.

## 2. ELIGIBILITY AND QUALIFICATION REQUIREMENTS FOR BIDDERS

1. **General Eligibility Criteria.** Bidders must meet the following requirements to participate in the bidding process:

- a. **Legal Status:** Must be a legally registered entity (or natural person, where applicable) with valid documentation.
- b. **Financial Standing:** Must demonstrate financial stability and capability to perform the contract.

- c. Experience: Must have relevant experience in similar contracts (minimum years/scope to be specified based on the procurement nature).
- d. Technical Capacity: Must possess the necessary technical expertise, equipment, and personnel to execute the contract.
- e. Compliance with Laws: Must not be debarred, blacklisted, or under sanctions (as per Section 10.4 of the Procurement Guidelines).

2. **Ineligible Bidders.** A bidder shall be disqualified if:

- a. They are debarred or blacklisted by the Procuring Entity (PE) or any relevant authority.
- b. They have provided consulting services for the same contract (conflict of interest).
- c. In case of Joint Ventures (JV):
- d. No JV partner can submit more than one bid (individually or collectively).
- e. They are from a country under UN sanctions (for natural persons: nationality; for legal entities: country of incorporation).

3. **Qualification Assessment.**

- a. After passing the preliminary examination, bids will undergo a detailed evaluation based on the following criteria:

<b>CRITERIA</b>	<b>JUDGMENT</b>
<b>Technical Evaluation</b>	- Compliance with required technical specifications including verification of proof of compliance with test reports/certificates - Scope of supply, delivery, or services. - Warranty, spare parts availability, and after-sales service requirements. Products/services may undergo testing/certification by designated institutions (e.g., <b>SLSI, SLITA, ITI, Moratuwa University</b> ) if specified in Section V.
<b>Commercial Evaluation</b>	- Terms of payment. - Delivery schedule or completion period. - Compliance with duties and taxes.
<b>Experience &amp; Past Performance</b>	- Experience in the respective field. - Experience in similar contracts.
<b>Financial</b>	Financial soundness of the bidder.
<b>Technical and managerial competence.</b>	<b>Technical Expertise and Project Management Strength</b> - Availability of <b>certified/qualified professionals</b> (engineers, technicians, specialists) -Proposed methodology. -and management plan. - Available resources (equipment & manpower). <b>Quality &amp; Compliance</b> - Technical certifications (ISO, industry-specific standards).
<b>Additional Considerations</b>	- Risk assessment. - Innovation & sustainability (if applicable).

b. Before awarding the contract, the selected lowest evaluated bidder will undergo a **final verification process** to confirm compliance with all financial, technical, and contractual requirements. The post-qualification verification will include:

(1) **Financial Capacity Review:** Ensuring the bidder can meet financial obligations considering current work commitments.

(2) **Performance Review:** Examination of past contract performance and compliance history including past SLAF experience with the bidder.

(3) Verification that the bidder meets all necessary legal (litigation, sanctions - please provide the details required by Form- VI of Section IV), and regulatory including Environmental compliance (if applicable).

(4) **Compliance with Contract Requirements:** Ensuring the bidder's agreement for the following contractual requirements as given in Section VI and Section VII.

S/No	Feature	Whether agreed by the firm	If deviates the reason
21.	Scope of Supply		
22.	Contract Price & Payment Terms		
23.	Quantity & Delivery		
24.	Transportation		
25.	Inspection & Tests		
26.	Rejection & Replacement		
27.	Warranty		
28.	Taxes & Duties		
29.	Signing of Contract		
30.	Performance Security		
31.	Liquidated Damages		
32.	Assumption of Compliance		
33.	Settlement of Disputes		
34.	Termination & Expiry of the Contract		
35.	Severability		
36.	Governing Law		
37.	Joint Venture		
38.	Force Majeure		
39.	Amendments		
40.	Confidentiality		

4. **Documentation Required.** Bidders must submit:

- a. Proof of legal registration (business license, tax certificates).
- b. Audited financial statements (last 3 years, if applicable).
- c. Experience records (similar projects completed).

d. Declaration of non-debarment and compliance with sanctions.



### **3. TECHNICAL SPECIFICATIONS**

<b>Name</b>	<b><u>MEDAL WITH RIBBON SRI LANKA AIR FORCE 75<sup>TH</sup> ANNIVERSARY (STANDARD)</u></b>
<b>SLAF PART NUMBER</b>	SLAF8455015063
<b>DESIGN</b>	As per Annex “A”
<b>GENERAL</b>	
1. 75 <sup>th</sup> Sri Lanka air force Anniversary Commemoration Medal with Ribbon (Standard) to be use in the SLAF	
2. The Medal shall be shaped from made of Cupro-nickel chromium plated (silver colour shining) signifying the protection of the sovereignty of Sri Lanka by the SLAF, with the Cmdr as its head with the assistance of the C of S, DGs and Establishment Cmdrs in accordance to the 10 Principles of War against the enemy, in the Centre, the figure 75 which signifies the dawn of 75 <sup>th</sup> Anniversary of the SLAF. The six petals around the medal represent six Bases in SLAF and 16 arrows heads signifies the sixteen Stations in SLAF. On the reverse side in the emblem, the year 2026, denoting the establishment of the SLAF and the date of the 75 <sup>th</sup> Anniversary of the SLAF respectively, while the wording of ‘Sri Lanka Air Force’ in Sinhala in the above of the emblem and the wording of ‘Sri Lanka Air Force’ in Tamil in bellow of the emblem surrounded by petals representing the blue lotus flower (Annex “A”).	
3. Supplier should specify/ certify the following; <ul style="list-style-type: none"> <li>Brand new product</li> <li>a. Country of Origin</li> <li>b. Country of Manufacturer</li> <li>c. Year of Manufacturer</li> <li>d. Bidder should supply medal with ribbon Sri Lanka Air Force 75<sup>th</sup> Anniversary (Standard) from original manufacturing institute.</li> </ul>	
4. Should submit ISO/SLS or equivalent certifications for the medal with ribbon Sri Lanka Air Force 75 <sup>th</sup> Anniversary (Standard) or manufacture.	
<b>TECHNICAL DETAILS</b>	
5. Design and dimensions as per the Annex “ A”	
6. Material – Cupro-nickel chromium plated (silver colour shining) <ul style="list-style-type: none"> <li>a. Cupro Nickel composition should be as follows; <ul style="list-style-type: none"> <li>i. CU – 62% to 66%</li> <li>ii. Nickel – 16.5% to 19.5%</li> <li>iii. Manganese – 0 to .5%</li> </ul> </li> </ul>	

<p>iv. Ferrous – 0 to .25%</p> <p>v. Remaining portion is zinc</p>
7. Thickness of the medal – 3mm to 3.5mm
8. Weight of the medal – 40g ± 2
9. Ribbon Material – Synthetic (Nylon/Polyester) woven ribbon.
10. It is ordained that the Medal shall be worn on the left breast suspended from a ribbon 3cm in width and 5cm in length of which the center part consist Nine (09) strips filled with the colours in sequence from left to right consisting as Yellow, Maroon, Dark Green, Saffron and then the Centre strip with Sky Blue and again reverse order of first 4 colours, as Saffron, dark Green, Maroon and at last Yellow signifying the colours of the SLAF Roundel and Ensign (Annex “A”).
<b>EXPERIENCE</b>
<p>11. Manufacture / supplier should submit reference documents and expertise personnel details for following</p> <p>a. Manufacture experience should be minimum 05 years</p> <p>b. Supplier experience should be minimum 03 years</p>
<b>WARRANTY</b>
12. Bidder should specify maximum warranty period from the date of supply.
<b>MISCELLANEOUS</b>
<p>13. Bidder should provide <b>10 Nos</b> of samples during the tender opening and bids without samples will be rejected. Cost of samples and other expenses/ damages occurred during/ laboratory testing/ field trials/ demonstration should be borne by the bidder.</p> <p>14. In case of honoring a bid without inspecting samples, the SLAF has its rights to reject item(s) which are found not confirmed to specifications at the time of acceptance.</p> <p>15. All eligible bidders are to pay <b>Rs.100, 000.00</b> of laboratory testing charges to Director Finance SLAF and copy of the receipt to be submitted along with the samples. The offers without the receipt of payment will not be accepted every additional offer same amount to be deposited with Director Finance (<b>Both standard &amp; miniature medal will be tested at well reputed testing laboratory in Sri Lanka</b>).</p> <p>16. The consignment is to be delivered to Supply and Maintenance Depot Sri Lanka Air Force Base Katunayake. Random sample taken out from delivered consignment will be tested at well reputed testing institute in Sri Lanka. The cost of testing charges should be borne by the supplier.</p>

17. Bidder should specify the past performance of supplying of medal for defence services in Sri Lanka (Last 3 years of time).

18. Bidder should specify the delivery period.

**DESIGN OF THE MEDAL**

**Obverse**



**Reverse**



SPECIFICATION OF THE MEDAL

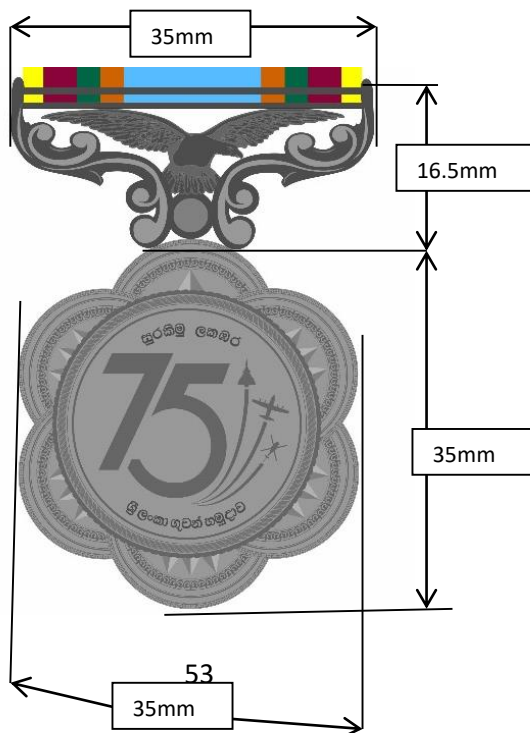
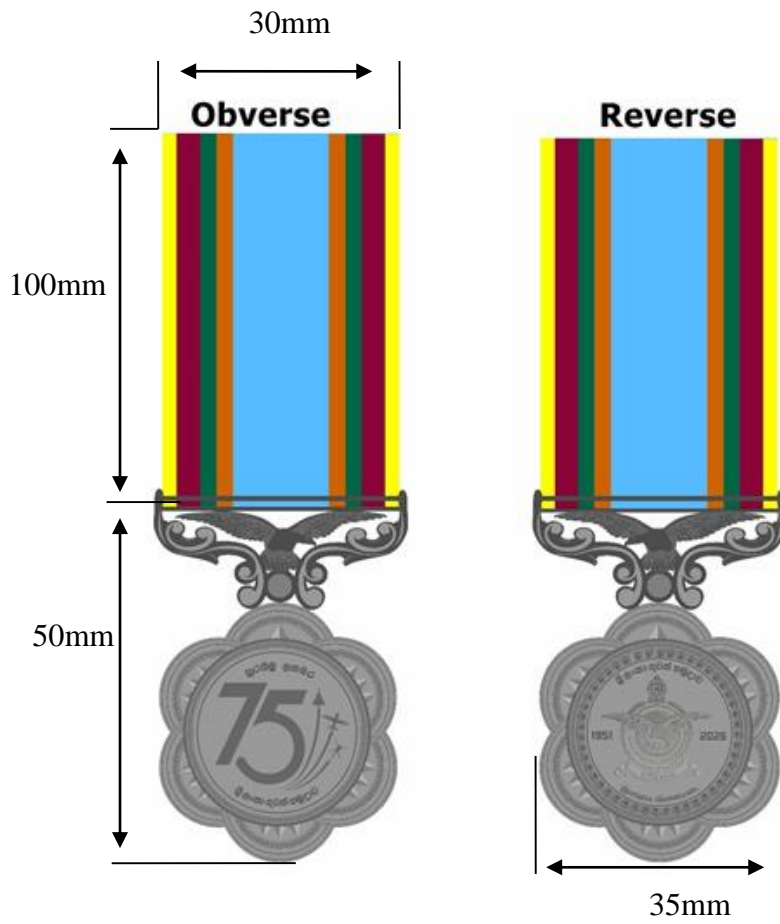

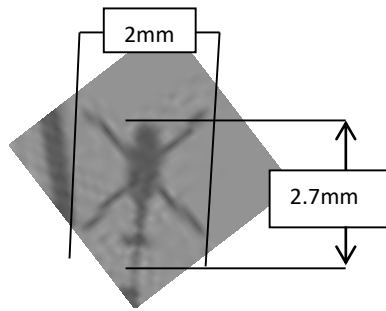
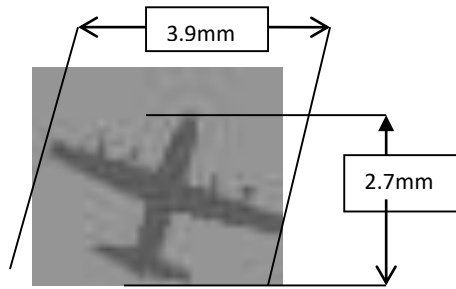
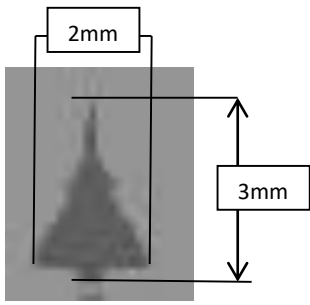

## OTHER DETAILS

Following titles are embossed in Sinhala and Tamil as below;

ශ්‍රී ලංකා ගුවන් හමුදාව

සුරකිමු ලකමර

இலங்கை விமானப்படை

## 75<sup>TH</sup> ANNIVERSARY MEDAL RIBBON (STANDARD)

### DESIGN OF THE MEDAL RIBBON

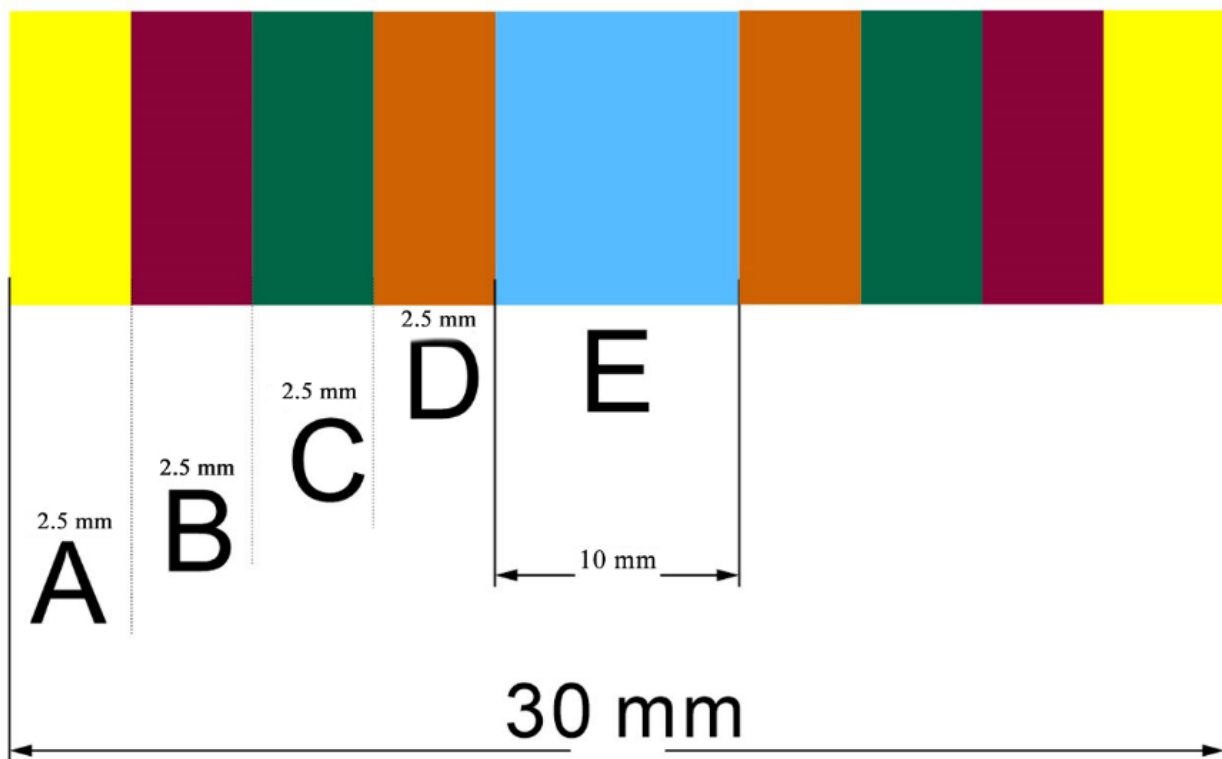

#### **RIBBON BAR COLORS**

- |               |   |  |
|---------------|---|--|
| A. Yellow     | } | Same colors as the Sir Lanka Air Force Roundel |
| B. Maroon     |   |  |
| C. Dark Green |   |  |
| D. Orange     |   |  |
| E. Light Blue |   | Same color as the Sir Lanka Air Force Ensign   |

#### DESCRIPTION OF THE MEDAL RIBBON

<b>Letter</b>	<b>Size (mm)</b>	<b>Colour</b>	<b>Remarks</b>
A	2.5	Yellow	Keeping in line with national identity of four concentric circles of these colours in proportion with the colours representation in the National Flag, which also used in the SLAF Roundel
B	2.5	Maroon	
C	2.5	Green	
D	2.5	Saffron	
E	10	Light Blue	Same colour as in the SLAF Ensign





<b>Name</b>	<b><u>MEDAL WITH RIBBON SRI LANKA AIR FORCE 75<sup>TH</sup> ANNIVERSARY (MINIATURE)</u></b>
<b>SLAF PART NUMBER</b>	SLAF8455015064
<b>DESIGN</b>	As per Annex “B”
<b>GENERAL</b>	
1. 75 <sup>th</sup> Sri Lanka air force Anniversary Commemoration Medal with Ribbon (Miniature) to be use in the SLAF	
2. The Medal shall be shaped from made of Cupro-nickel chromium plated (silver colour shining) signifying the protection of the sovereignty of Sri Lanka by the SLAF, with the Cmdr as its head with the assistance of the C of S, DGs and Establishment Cmdrs in accordance to the 10 Principles of War against the enemy, in the Centre, the figure 75 which signifies the dawn of 75th Anniversary of the SLAF. The six petals around the medal represent six Bases in SLAF and 16 arrows heads signifies the sixteen Stations in SLAF. On the reverse side in the emblem, the year 2026, denoting the establishment of the SLAF and the date of the 75th Anniversary of the SLAF respectively, while the wording of ‘Sri Lanka Air Force’ in Sinhala in the above of the emblem and the wording of ‘Sri Lanka Air Force’ in Tamil in bellow of the emblem surrounded by petals representing the blue lotus flower (Annex “A”).	
3. Supplier should specify/ certify the following; <ul style="list-style-type: none"> <li>a. Brand new product</li> <li>b. Country of Origin</li> <li>c. Country of Manufacturer</li> <li>d. Year of Manufacturer</li> <li>e. Bidder should supply medal with ribbon Sri Lanka Air Force 75<sup>th</sup> Anniversary (Miniature) from original manufacturing institute.</li> </ul>	
4. Should submit ISO/SLS or equivalent certifications for the medal with ribbon Sri Lanka Air Force 75 <sup>th</sup> Anniversary (Miniature) or manufacture.	
<b>TECHNICAL DETAILS</b>	
5. Design and dimensions as per the Annex “ A” (Half of the size of standard medal)	
6. Material – Cupro-nickel chromium plated (silver colour shining) <ul style="list-style-type: none"> <li>a. Cupro Nickel composition should be as follows; <ul style="list-style-type: none"> <li>i. CU – 62% to 66%</li> <li>ii. Nickel – 16.5% to 19.5%</li> <li>iii. Manganese – 0 to .5%</li> </ul> </li> </ul>	

<p>iv. Ferrous – 0 to .25%</p> <p>v. Remaining portion is zinc</p>
7. Thickness of the medal – 1.5mm to 1.7mm
8. Weight of the medal – 10g (Approximately)
9. Ribbon Material – Synthetic (Nylon/Polyester) woven ribbon.
10. The Medal Ribbon shall be in Nine (09) strips filled with the colours in sequence from left to right consisting as Yellow, Maroon, Dark Green, Saffron and then the Centre strip with Sky Blue and again reverse order of first 4 colours, as Saffron, dark Green, Maroon and at last Yellow signifying the colours of the SLAF Roundel and Ensign (Annex “A”).
<b>EXPERIENCE</b>
<p>11. Manufacture / supplier should submit reference documents and expertise personnel details for following</p> <p>a. Manufacture experience should be minimum 05 years</p> <p>b. Supplier experience should be minimum 03 years</p>
<b>WARRANTY</b>
12. Bidder should specify maximum warranty period from the date of supply.
<b>MISCELLANEOUS</b>
<p>13. Bidder should provide <b>10 Nos</b> of samples during the tender opening and bids without samples will be rejected. Cost of samples and other expenses/ damages occurred during/ laboratory testing/ field trials/ demonstration should be borne by the bidder.</p> <p>14. In case of honoring a bid without inspecting samples, the SLAF has its rights to reject item(s) which are found not confirmed to specifications at the time of acceptance.</p> <p>15. Bidder should specify the past performance of supplying of medal for defence services in Sri Lanka (Last 3 years of time).</p> <p>16. Bidder should specify the delivery period.</p>

**75<sup>TH</sup> ANNIVERSARY MEDAL (MINIATURE)**

**DESIGN OF THE MEDAL**

**Obverse**



**Reverse**



SPECIFICATION OF THE MEDAL

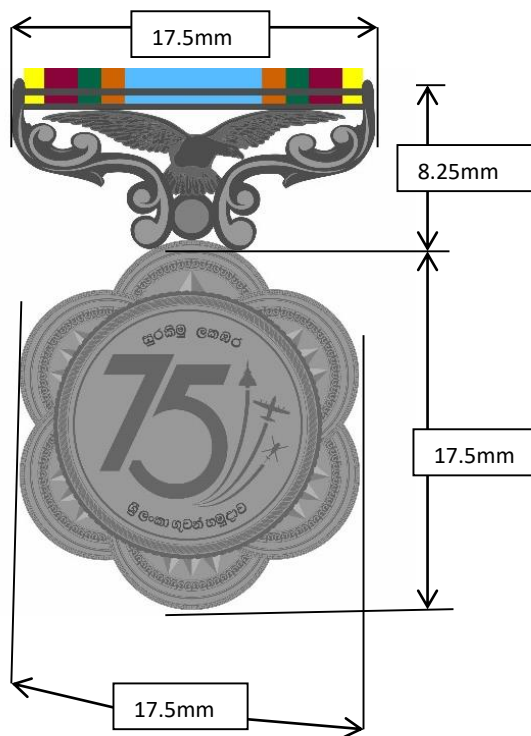
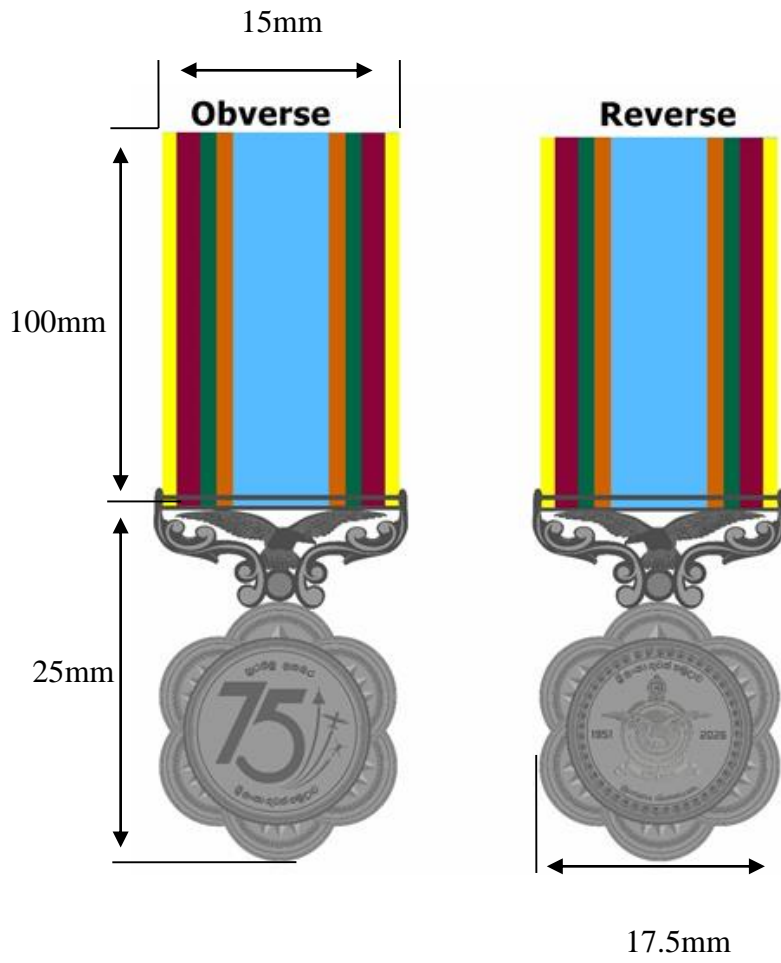

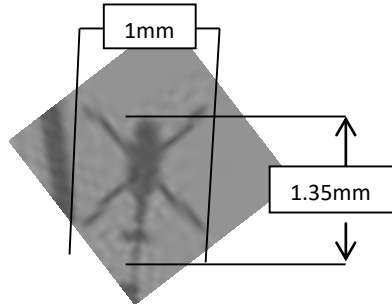
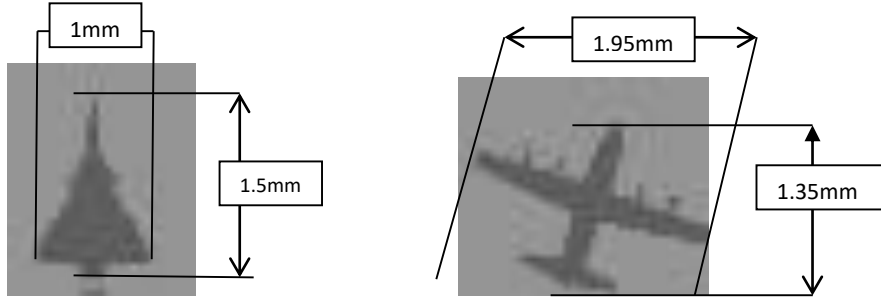

### OTHER DETAILS

Following titles are embossed in Sinhala and Tamil as below;

ශ්‍රී ලංකා ඉවන් හමුදාව

සුරකිමු ලකඹර

இலங்கை விமானப்படை

## 75<sup>TH</sup> ANNIVERSARY MEDAL RIBBON (MINIATURE)

### DESIGN OF THE MEDAL RIBBON

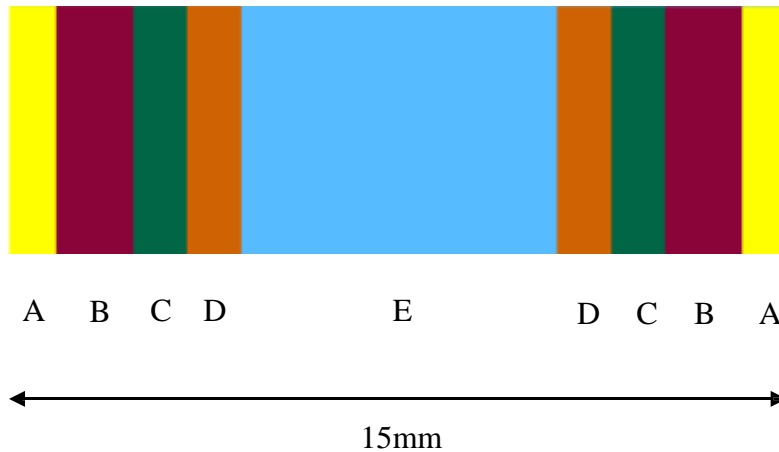

### DESCRIPTION OF THE MEDAL RIBBON

Letter	Size (mm)	Colour	Remarks
A	1.25	Yellow	Keeping in line with national identity of four concentric circles of these colours in proportion with the colours representation in the National Flag, which also used in the SLAF Roundel
B	1.25	Maroon	
C	1.25	Green	
D	1.25	Saffron	
E	05	Light Blue	Same colour as in the SLAF Ensign

#### 4. DRAWINGS

##### 75<sup>TH</sup> ANNIVERSARY MEDAL (STANDARD)

##### DESIGN OF THE MEDAL





SPECIFICATION OF THE MEDAL

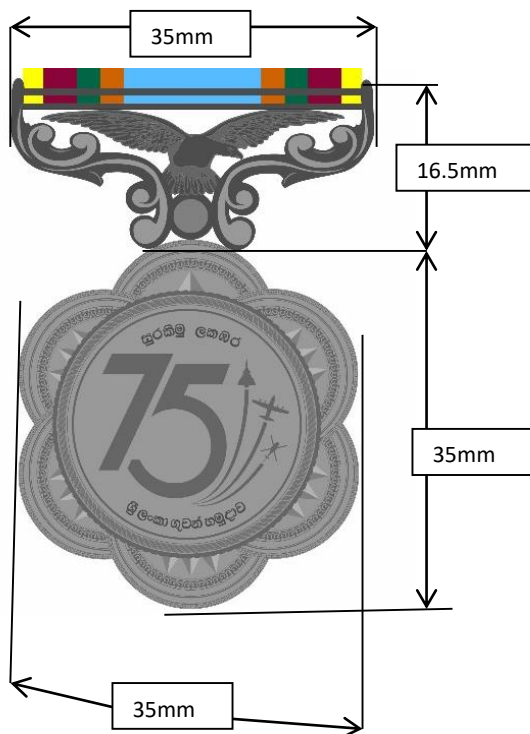
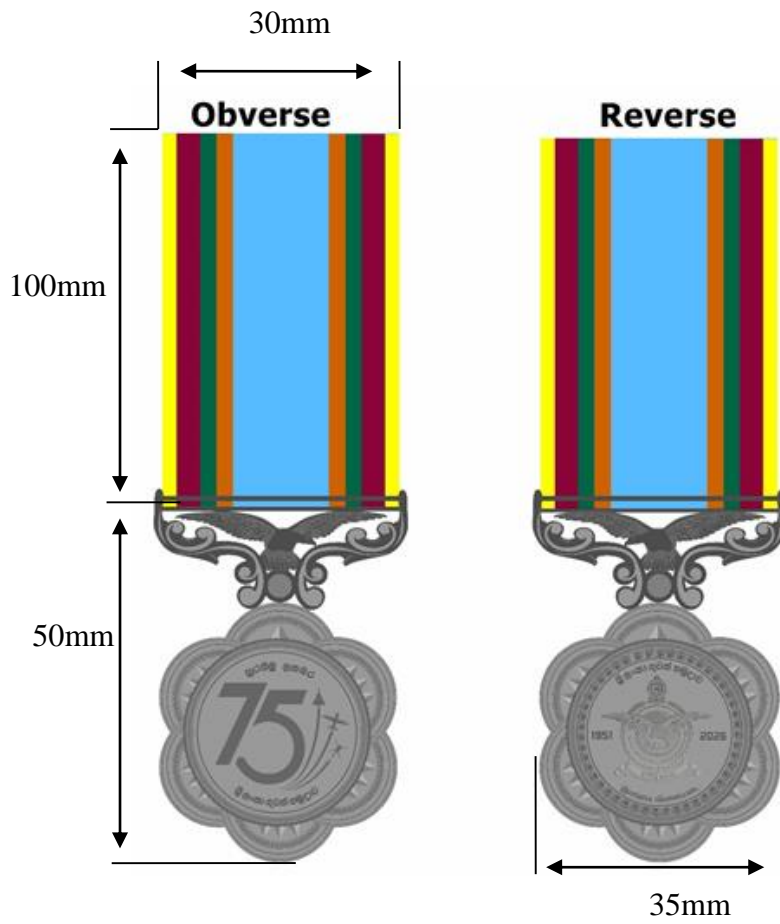

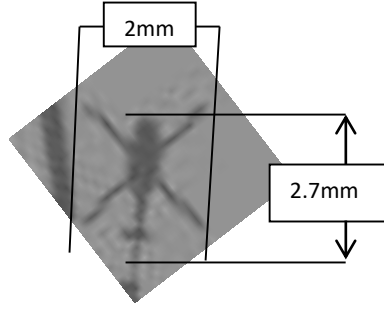
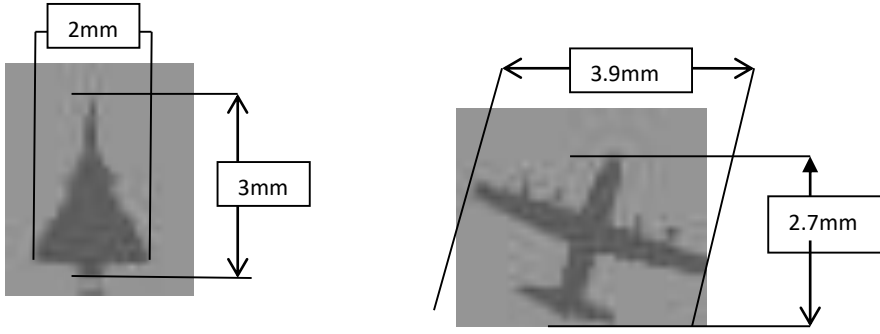

### OTHER DETAILS

Following titles are embossed in Sinhala and Tamil as below;

ශ්‍රී ලංකා ගුවන් හමුදාව

සුරකිමු ලකඹර

இலங்கை விமானப்படை

75<sup>TH</sup> ANNIVERSARY MEDAL RIBBON (STANDARD)

DESIGN OF THE MEDAL RIBBON

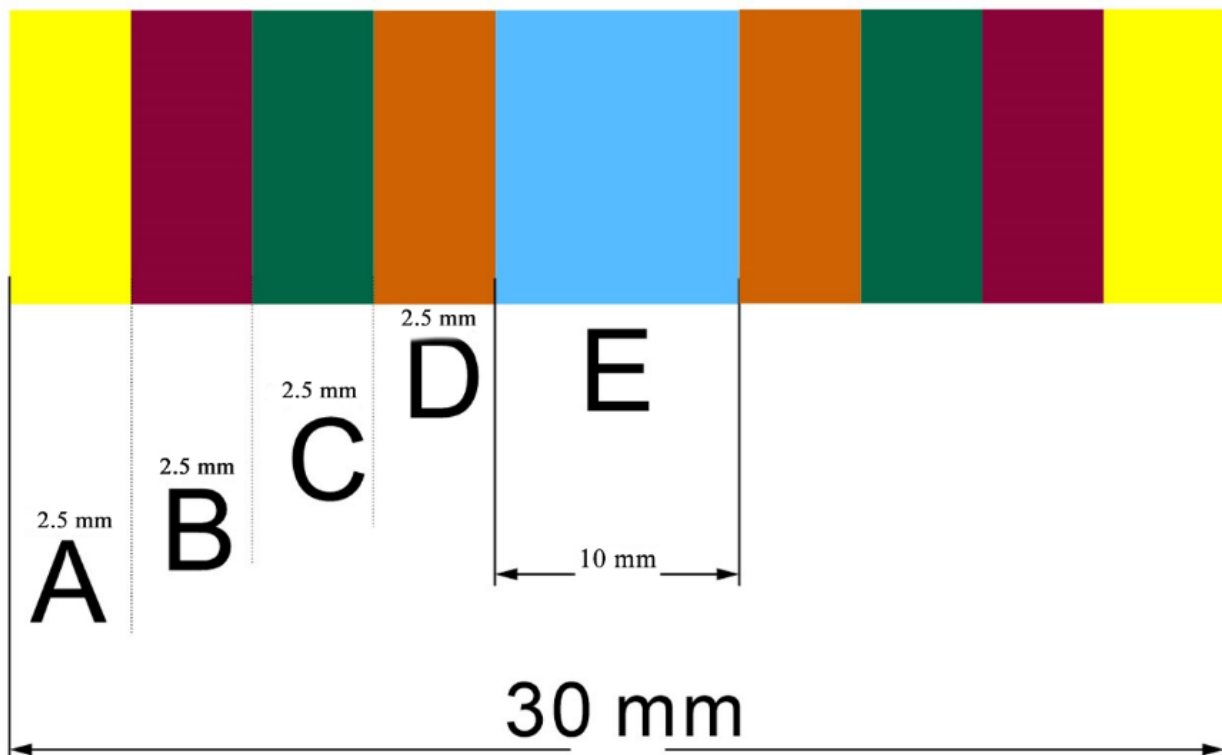

**RIBBON BAR COLORS**

- A. Yellow
  - B. Maroon
  - C. Dark Green
  - D. Orange
  - E. Light Blue
- Same colors as the Sir Lanka Air Force Roundel
- Same color as the Sir Lanka Air Force Ensign

**75<sup>TH</sup> ANNIVERSARY MEDAL (MINIATURE)**

**DESIGN OF THE MEDAL**

**Obverse**



**Reverse**



SPECIFICATION OF THE MEDAL

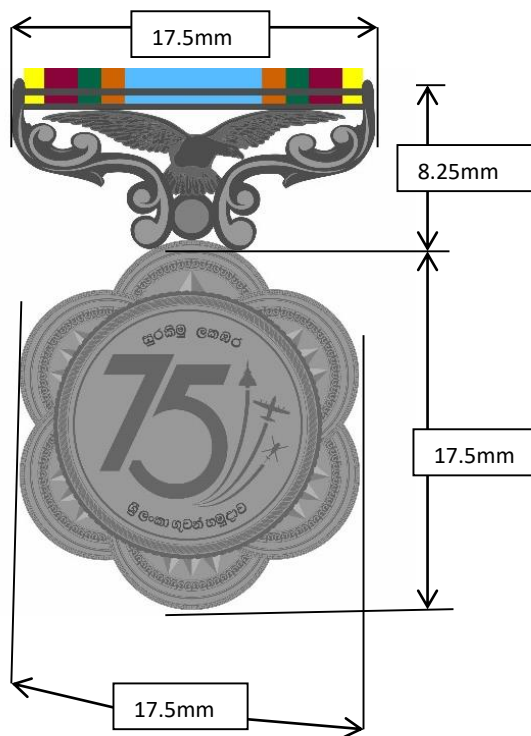
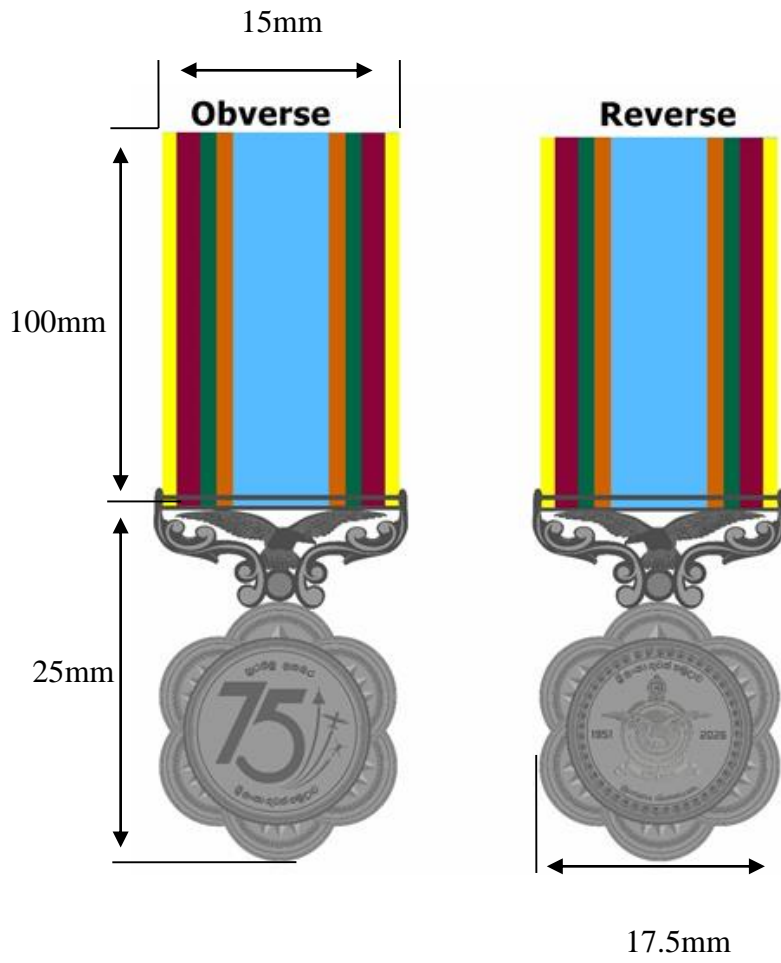

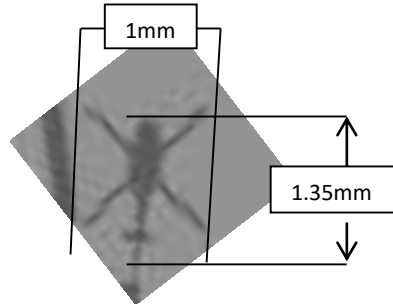
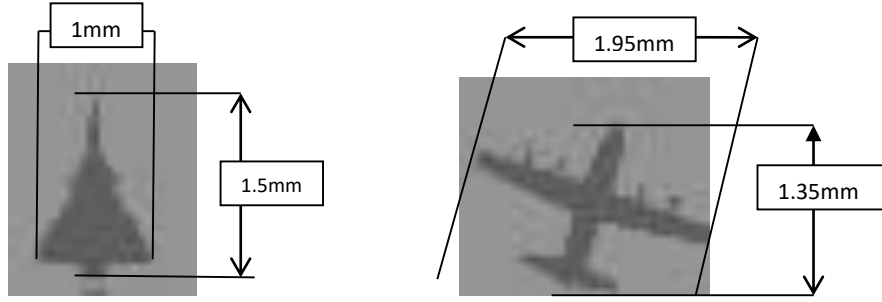

### OTHER DETAILS

Following titles are embossed in Sinhala and Tamil as below;

ශ්‍රී ලංකා ඉතිහාස චරිත

සුරකිමු ලකමර

இலங்கை விமானப்படை

75<sup>TH</sup> ANNIVERSARY MEDAL RIBBON (MINIATURE)

DESIGN OF THE MEDAL RIBBON

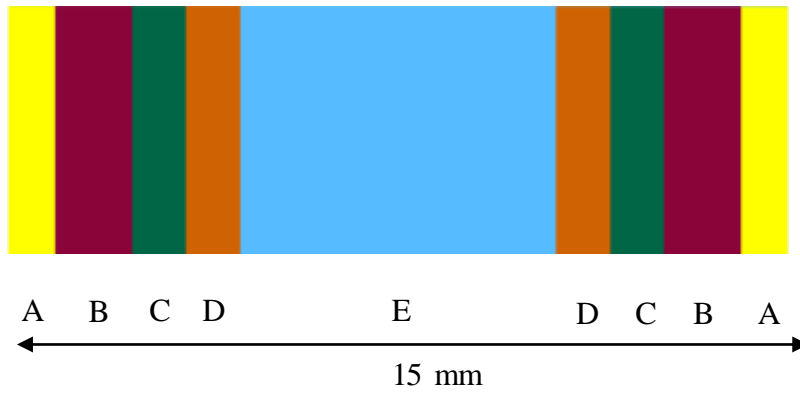

## 5. INSPECTIONS AND TESTS

*“Bidders are required to provide physical samples that fully comply with the specified requirements. Samples must be clearly labelled for easy identification, including the Bidder’s name, Tender reference, and corresponding item number. Bids submitted without the required samples will be rejected. Further, a non-refundable sample testing fee of Rs. 100,000.00 shall be deposited. The original receipt issued by the Director Finance of SLAF must be attached to the original bid and presented at the time of bid opening. Further, during the bulk delivery a random sample from each bulk delivery will be tested by an institute nominated by the SLAF, with the testing costs to be borne by the bidder. ”*



## Section VI

### Conditions of Contract

SECTION	CLAUSE	TEXT
<b>DEFINITIONS</b>	1. Definitions	<p>1.1 The following words and expressions shall have the meanings hereby assigned to them:</p> <p>(a) “Contract” means the Contract Agreement entered into between the Purchaser and the Supplier, together with the Contract Documents referred to therein, including all attachments, appendices, and all documents incorporated by reference therein.</p> <p>(b) “Contract Documents” means the documents listed in the Contract Agreement, including any amendments thereto.</p> <p>(c) “Contract Price” means the price payable to the Supplier as specified in the Contract Agreement, subject to such additions and adjustments thereto or deductions therefrom, as may be made pursuant to the Contract.</p> <p>(d) “Day” means calendar day.</p> <p>(e) “Completion” means the fulfillment of the supply of Goods to the destination specified and completion of the Related Services by the Supplier in accordance with the terms and conditions set forth in the Contract.</p> <p>(f) “CC” means the Conditions of Contract.</p> <p>(g) “Goods” means all of the commodities, raw material, machinery and equipment, and/or other materials that the Supplier is required to supply to the Purchaser under the Contract.</p> <p>(h) “Purchaser” means the entity purchasing the Goods and Related Services, as specified in the Contract Data.</p> <p>(i) “Related Services” means the services incidental to the supply of the goods, such as insurance, installation, training and initial maintenance and other such obligations of the Supplier under the Contract.</p> <p>(j) “Subcontractor” means any natural person, private or government entity, or a combination of the above, to whom any part of the Goods to be supplied or execution of any part of the Related Services is subcontracted by the Supplier.</p> <p>(k) “Supplier” means the natural person, private or government entity, or a combination of the above, whose bid to perform the Contract has been accepted by the Purchaser and is named as such in the Contract Agreement.</p>

		(l) "The Project Site," where applicable, means the place named in the Contract Data.
<b>Contract Documents</b>	2. Contract Documents	2.1 Subject to the order of precedence set forth in the Contract Agreement, all documents forming the Contract (and all parts thereof) are intended to be correlative, complementary, and mutually explanatory. The Contract Agreement shall be read as a whole.
<b>Fraud and Corruption</b>	3. Fraud and Corruption	3.1 The Government of Sri Lanka requires the Purchaser as well as bidders, suppliers, contractors, and consultants to observe the highest standard of ethics during the procurement and execution of such contracts. In pursuit of this policy: (i) "corrupt practice" means offering, giving, receiving, or soliciting, directly or indirectly, of anything of value to influence the action of a public official in the procurement process or in contract execution; (ii) "fraudulent practice" means a misrepresentation or omission of facts in order to influence a procurement process or the execution of a contract; (iii) "collusive practice" means a scheme or arrangement between two or more bidders, with or without the knowledge of the Purchaser to establish bid prices at artificial, non-competitive levels; and (iv) "coercive practice" means harming or threatening to harm, directly or indirectly, persons or their property to influence their participation in the procurement process or affect the execution of a contract.
<b>Interpretation</b>	4. Interpretation	4.1 If the context so requires it, singular means plural and vice versa. 4.2 Entire Agreement: The Contract constitutes the entire agreement between the Purchaser and the Supplier and supersedes all communications, negotiations and agreements (whether written or oral) of the parties with respect thereto made prior to the date of Contract. 4.3 Amendment: No amendment or other variation of the Contract shall be valid unless it is in writing, is dated, expressly refers to the Contract, and is signed by a duly authorized representative of each party thereto. 4.4 Severability: If any provision or condition of the Contract is prohibited or rendered invalid or unenforceable, such prohibition, invalidity or

		unenforceability shall not affect the validity or enforceability of any other provisions and conditions of the Contract.
<b>Language</b>	5. Language	<p>5.1 The Contract as well as all correspondence and documents relating to the Contract exchanged by the Supplier and the Purchaser, shall be written in English language. Supporting documents and printed literature that are part of the Contract may be in another language provided they are accompanied by an accurate translation of the relevant passages in the language specified, in which case, for purposes of interpretation of the Contract, this translation shall govern.</p> <p>5.2 The Supplier shall bear all costs of translation to the governing language and all risks of the accuracy of such translation, for documents provided by the Supplier.</p>
<b>Joint Venture, Consortium or Association</b>	6. Joint Venture, Consortium or Association	6.1 If the Supplier is a joint venture, consortium, or association, all of the parties shall be jointly and severally liable to the Purchaser for the fulfillment of the provisions of the Contract and shall designate one party to act as a leader with authority to bind the joint venture, consortium, or association. The composition or the constitution of the joint venture, consortium, or association shall not be altered without the prior consent of the Purchaser.
<b>Eligibility</b>	7. Eligibility	7.1 All goods supplied under this contract shall be complied with applicable standards stipulated by the Sri Lanka Standards Institute. In the absence of such standards, the Goods supplied shall be complied to other internationally accepted standards, such as British Standards.
<b>Notices</b>	8. Notices	<p>8.1 Any notice given by one party to the other pursuant to the Contract shall be in writing to the address specified in the Contract Data. The term “in writing” means communicated in written form with proof of receipt.</p> <p>8.2 A notice shall be effective when delivered or on the notice’s effective date, whichever is later.</p>
<b>Governing Law</b>	9. Governing Law	9.1 The Contract shall be governed by and interpreted in accordance with the laws of the Democratic Socialist Republic of Sri Lanka.
<b>Settlement of Disputes</b>	10. Settlement of Disputes	10.1 The Purchaser and the Supplier shall make every effort to resolve amicably by direct informal negotiation any disagreement or dispute arising between them under or in connection with the Contract.

		<p>10.2 If, after twenty-eight (28) days, the parties have failed to resolve their dispute or difference by such mutual consultation, then either the Purchaser or the Supplier may give notice to the other party of its intention to commence arbitration, as hereinafter provided, as to the matter in dispute, and no arbitration in respect of this matter may be commenced unless such notice is given. Any dispute or difference in respect of which a notice of intention to commence arbitration has been given in accordance with this Clause shall be finally settled by arbitration. Arbitration may be commenced prior to or after delivery of the Goods under the Contract. Arbitration proceedings shall be conducted in accordance with the Arbitration Act No:11 of 1995.</p> <p>10.3 Notwithstanding any reference to arbitration herein,</p> <p>(a) the parties shall continue to perform their respective obligations under the Contract unless they otherwise agree; and</p> <p>(b) the Purchaser shall pay the Supplier any monies due the Supplier.</p>
<b>Scope of Supply</b>	11. Scope of Supply	11.1 The Goods and Related Services to be supplied shall be as specified in the Schedule of Requirements.
<b>Delivery and Documents</b>	12. Delivery and Documents	12.1 Subject to CC Sub-Clause 32.1, the Delivery of the Goods and Completion of the Related Services shall be in accordance with the Delivery and Completion Schedule specified in the Schedule of Requirements. Where applicable the details of shipping and other documents to be furnished by the Supplier are specified in the Contract Data.
<b>Supplier's Responsibilities</b>	13. Supplier's Responsibilities	13.1 The Supplier shall supply all the Goods and Related Services included in the Scope of Supply in accordance with CC Clause 11, and the Delivery and Completion Schedule, as per CC Clause 12.
<b>Contract Price</b>	14. Contract Price	14.1 Prices charged by the Supplier for the Goods supplied and the Related Services performed under the Contract shall not exceed the Contract Price.
<b>Terms of Payment</b>	15. Terms of Payment	<p>15.1 The Contract Price, shall be paid as specified in the <b>Contract Data</b>.</p> <p>15.2 The Supplier's request for payment shall be made to the Purchaser in writing, accompanied by invoices describing, as appropriate, the Goods delivered and Related Services</p>

		<p>performed, and by the documents submitted pursuant to CC Clause 12 and upon fulfillment of all other obligations stipulated in the Contract.</p> <p>15.3 Payments shall be made promptly by the Purchaser, but in no case later than 45 days after submission of an invoice or request for payment by the Supplier, and after the Purchaser has accepted it.</p>
<b>Taxes and Duties</b>	16. Taxes and Duties	16.1 The Supplier shall be entirely responsible for all taxes, duties, license fees, etc., incurred until delivery of the contracted Goods to the Purchaser.
<b>Performance Security</b>	17. Performance Security	<p>17.1 If required as specified in the <b>Contract Data</b>, the Supplier shall, within fourteen (14) days of the notification of contract award, provide a performance security of Ten percent (10%) of the Contract Price for the performance of the Contract.</p> <p>17.2 The proceeds of the Performance Security shall be payable to the Purchaser as compensation for any loss resulting from the Supplier's failure to complete its obligations under the Contract.</p> <p>17.3 As specified in the <b>Contract Data</b>, the Performance Security, if required, shall be in Sri Lanka Rupees and shall be in the format stipulated by the Purchaser in the <b>Contract Data</b>, or in another format acceptable to the Purchaser.</p> <p>17.4 The Performance Security shall be discharged by the Purchaser and returned to the Supplier not later than twenty-eight (28) days following the date of Completion of the Supplier's performance obligations under the Contract, including any warranty obligations.</p>
<b>Copyright</b>	18. Copyright	18.1 The copyright in all drawings, documents, and other materials containing data and information furnished to the Purchaser by the Supplier herein shall remain vested in the Supplier, or, if they are furnished to the Purchaser directly or through the Supplier by any third party, including suppliers of materials, the copyright in such materials shall remain vested in such third party.
<b>Confidential Information</b>	19. Confidential Information	19.1 The Purchaser and the Supplier shall keep confidential and shall not, without the written consent of the other party hereto, divulge to any third party any documents, data, or other information furnished directly or indirectly by

		<p>the other party hereto in connection with the Contract, whether such information has been furnished prior to, during or following completion or termination of the Contract. Notwithstanding the above, the Supplier may furnish to its Subcontractor such documents, data, and other information it receives from the Purchaser to the extent required for the Subcontractor to perform its work under the Contract, in which event the Supplier shall obtain from such Subcontractor an undertaking of confidentiality similar to that imposed on the Supplier under CC Clause 19.</p> <p>19.2 The Purchaser shall not use such documents, data, and other information received from the Supplier for any purposes unrelated to the contract. Similarly, the Supplier shall not use such documents, data, and other information received from the Purchaser for any purpose other than the performance of the Contract.</p> <p>19.3 The above provisions of CC Clause 19 shall not in any way modify any undertaking of confidentiality given by either of the parties hereto prior to the date of the Contract in respect of the Supply or any part thereof.</p> <p>19.4 The provisions of CC Clause 19 shall survive completion or termination, for whatever reason, of the Contract.</p>
<b>Subcontracting</b>	20. Subcontracting	<p>20.1 The Supplier shall notify the Purchaser in writing of all subcontracts awarded under the Contract if not already specified in the bid. Such notification, in the original bid or later shall not relieve the Supplier from any of its obligations, duties, responsibilities, or liability under the Contract.</p> <p>20.2 Subcontracts shall comply with the provisions of CC Clauses 3 and 7.</p>
<b>Specifications and Standards</b>	21. Specifications and Standards	<p>21.1 Technical Specifications and Drawings:</p> <p>(a) The Goods and Related Services supplied under this Contract shall conform to the technical specifications and standards mentioned in Section V, Schedule of Requirements and, when no applicable standard is mentioned, the standard shall be equivalent or superior to the official standards whose application is appropriate to the Goods' country of origin.</p> <p>(b) The Supplier shall be entitled to disclaim responsibility for any design, data, drawing, specification or other document, or any</p>

		<p>modification thereof provided or designed by or on behalf of the Purchaser, by giving a notice of such disclaimer to the Purchaser.</p> <p>(c) Wherever references are made in the Contract to codes and standards in accordance with which it shall be executed, the edition or the revised version of such codes and standards shall be those specified in the Schedule of Requirements. During Contract execution, any changes in any such codes and standards shall be applied only after approval by the Purchaser and shall be treated in accordance with CC Clause 32.</p>
<b>Packing and Documents</b>	22. Packing and Documents	22.1 The Supplier shall pack the Goods as is required to prevent their damage or deterioration during transit to their final destination, as indicated in the Contract.
<b>Insurance</b>	23. Insurance	23.1 Unless otherwise specified in the <b>Contract Data</b> , the Goods supplied under the Contract shall be fully insured against loss or damage incidental to manufacture or acquisition, transportation, storage, and delivery.
<b>Transportation</b>	24. Transportation	24.1 Unless otherwise specified in the <b>Contract Data</b> , responsibility for arranging transportation of the Goods shall be a responsibility of the supplier.
<b>Inspections and Tests</b>	25. Inspections and Tests	<p>25.1 The Supplier shall at its own expense and at no cost to the Purchaser carry out all such tests and/or inspections of the Goods and Related Services as are specified in the <b>Contract Data</b>.</p> <p>25.2 The inspections and tests may be conducted on the premises of the Supplier or its Subcontractor, at point of delivery, and/or at the Goods' final destination, or in another place as specified in the Contract Data. Subject to CC Sub-Clause 25.3, if conducted on the premises of the Supplier or its Subcontractor, all reasonable facilities and assistance, including access to drawings and production data, shall be furnished to the inspectors at no charge to the Purchaser.</p> <p>25.3 The Purchaser or its designated representative shall be entitled to attend the tests and/or inspections referred to in CC Sub-Clause 25.2, provided that the Purchaser bear all of its own costs and expenses incurred in connection with such attendance including, but not limited to, all traveling and board and lodging expenses.</p> <p>25.4 Whenever the Supplier is ready to carry out any such test and inspection, it shall give a</p>

		<p>reasonable advance notice, including the place and time, to the Purchaser. The Supplier shall obtain from any relevant third party or manufacturer any necessary permission or consent to enable the Purchaser or its designated representative to attend the test and/or inspection.</p> <p>25.5 The Purchaser may require the Supplier to carry out any test and/or inspection not required by the Contract but deemed necessary to verify that the characteristics and performance of the Goods comply with the technical specifications codes and standards under the Contract, provided that the Supplier's reasonable costs and expenses incurred in the carrying out of such test and/or inspection shall be added to the Contract Price. Further, if such test and/or inspection impedes the progress of manufacturing and/or the Supplier's performance of its other obligations under the Contract, due allowance will be made in respect of the Delivery Dates and Completion Dates and the other obligations so affected.</p> <p>25.6 The Supplier shall provide the Purchaser with a report of the results of any such test and/or inspection.</p> <p>25.7 The Purchaser may reject any Goods or any part thereof that fail to pass any test and/or inspection or do not conform to the specifications. The Supplier shall either rectify or replace such rejected Goods or parts thereof or make alterations necessary to meet the specifications at no cost to the Purchaser, and shall repeat the test and/or inspection, at no cost to the Purchaser, upon giving a notice pursuant to CC Sub-Clause 25.4.</p> <p>25.8 The Supplier agrees that neither the execution of a test and/or inspection of the Goods or any part thereof, nor the attendance by the Purchaser or its representative, nor the issue of any report pursuant to CC Sub-Clause 25.6, shall release the Supplier from any warranties or other obligations under the Contract.</p>
<p><b>Liquidated Damages</b></p>	<p>26. Liquidated Damages</p>	<p>26.1 Except as provided under CC Clause 31, if the Supplier fails to deliver any or all of the Goods by the Date(s) of delivery or perform the Related Services within the period specified in the Contract, the Purchaser may without prejudice to all its other remedies under the Contract, deduct from the Contract Price, as</p>



		liquidated damages, a sum equivalent to the percentage specified in the Contract Data of the delivered price of the delayed Goods or unperformed Services for each week or part thereof of delay until actual delivery or performance, up to a maximum deduction of the percentage specified in those <b>Contract Data</b> . Once the maximum is reached, the Purchaser may terminate the Contract pursuant to CC Clause 34.
<b>Warranty</b>	27. Warranty	<p>27.1 The Supplier warrants that all the Goods are new, unused, and of the most recent or current models, and that they incorporate all recent improvements in design and materials, unless provided otherwise in the Contract.</p> <p>27.2 Subject to CC Sub-Clause 21.1(b), the Supplier further warrants that the Goods shall be free from defects arising from any act or omission of the Supplier or arising from design, materials, and workmanship, under normal use in the conditions prevailing in the country of final destination.</p> <p>27.3 Unless otherwise specified in the <b>Contract Data</b>, the warranty shall remain valid for twelve (12) months after the Goods, or any portion thereof as the case may be, have been delivered to and accepted at the final destination indicated in the Contract Data.</p> <p>27.4 The Purchaser shall give notice to the Supplier stating the nature of any such defects together with all available evidence thereof, promptly following the discovery thereof. The Purchaser shall afford all reasonable opportunity for the Supplier to inspect such defects.</p> <p>27.5 Upon receipt of such notice, the Supplier shall, within the period specified in the Contract Data, expeditiously repair or replace the defective Goods or parts thereof, at no cost to the Purchaser.</p> <p>27.6 If having been notified, the Supplier fails to remedy the defect within the period specified in the <b>Contract Data</b>, the Purchaser may proceed to take within a reasonable period such remedial action as may be necessary, at the Supplier's risk and expense and without prejudice to any other rights which the Purchaser may have against the Supplier under the Contract.</p>
<b>Patent Indemnity</b>	28. Patent Indemnity	<p>28.1 The Supplier shall, subject to the Purchaser's compliance with CC Sub-Clause 28.2, indemnify and hold harmless the</p>

		<p>Purchaser and its employees and officers from and against any and all suits, actions or administrative proceedings, claims, demands, losses, damages, costs, and expenses of any nature, including attorney's fees and expenses, which the Purchaser may suffer as a result of any infringement or alleged infringement of any patent, utility model, registered design, trademark, copyright, or other intellectual property right registered or otherwise existing at the date of the Contract by reason of:</p> <p>(a) the installation of the Goods by the Supplier or the use of the Goods in the country where the Site is located; and</p> <p>(b) the sale in any country of the products produced by the Goods. Such indemnity shall not cover any use of the Goods or any part thereof other than for the purpose indicated by or to be reasonably inferred from the Contract, neither any infringement resulting from the use of the Goods or any part thereof, or any products produced thereby in association or combination with any other equipment, plant, or materials not supplied by the Supplier, pursuant to the Contract.</p> <p>28.2 If any proceedings are brought or any claim is made against the Purchaser arising out of the matters referred to in CC Sub-Clause 28.1, the Purchaser shall promptly give the Supplier a notice thereof, and the Supplier may at its own expense and in the Purchaser's name conduct such proceedings or claim and any negotiations for the settlement of any such proceedings or claim.</p> <p>28.3 If the Supplier fails to notify the Purchaser within twenty-eight (28) days after receipt of such notice that it intends to conduct any such proceedings or claim, then the Purchaser shall be free to conduct the same on its own behalf.</p> <p>28.4 The Purchaser shall, at the Supplier's request, afford all available assistance to the Supplier in conducting such proceedings or claim, and shall be reimbursed by the Supplier for all reasonable expenses incurred in so doing.</p> <p>28.5 The Purchaser shall indemnify and hold harmless the Supplier and its employees, officers, and Subcontractors from and against any and all suits, actions or administrative proceedings, claims, demands, losses, damages, costs, and expenses of any nature, including</p>
--	--	---

		attorney's fees and expenses, which the Supplier may suffer as a result of any infringement or alleged infringement of any patent, utility model, registered design, trademark, copyright, or other intellectual property right registered or otherwise existing at the date of the Contract arising out of or in connection with any design, data, drawing, specification, or other documents or materials provided or designed by or on behalf of the Purchaser.
<b>Limitation of Liability</b>	29. Limitation of Liability	29.1 Except in cases of criminal negligence or wilful misconduct, (a) the Supplier shall not be liable to the Purchaser, whether in contract, tort, or otherwise, for any indirect or consequential loss or damage, loss of use, loss of production, or loss of profits or interest costs, provided that this exclusion shall not apply to any obligation of the Supplier to pay liquidated damages to the Purchaser and (b) the aggregate liability of the Supplier to the Purchaser, whether under the Contract, in tort or otherwise, shall not exceed the total Contract Price, provided that this limitation shall not apply to the cost of repairing or replacing defective equipment, or to any obligation of the supplier to indemnify the purchaser with respect to patent infringement.
<b>Change in Laws and Regulations</b>	30. Change in Laws and Regulations	30.1 Unless otherwise specified in the Contract, if after the date of 28 days prior to date of Bid submission, any law, regulation, ordinance, order or bylaw having the force of law is enacted, promulgated, abrogated, or changed in Sri Lanka that subsequently affects the Delivery Date and/or the Contract Price, then such Delivery Date and/or Contract Price shall be correspondingly increased or decreased, to the extent that the Supplier has thereby been affected in the performance of any of its obligations under the Contract. Notwithstanding the foregoing, such additional or reduced cost shall not be separately paid or credited if the same has already been accounted for in the price adjustment provisions where applicable, in accordance with CC Clause 14.
<b>Force Majeure</b>	31. Force Majeure	31.1 The Supplier shall not be liable for forfeiture of its Performance Security, liquidated damages, or termination for default if and to the extent that its delay in performance or other failure to perform its obligations under the

		<p>Contract is the result of an event of Force Majeure.</p> <p>31.2 For purposes of this Clause, “Force Majeure” means an event or situation beyond the control of the Supplier that is not foreseeable, is unavoidable, and its origin is not due to negligence or lack of care on the part of the Supplier. Such events may include, but not be limited to, acts of the Purchaser in its sovereign capacity, wars or revolutions, fires, floods, epidemics, quarantine restrictions, and freight embargoes.</p> <p>31.3 If a Force Majeure situation arises, the Supplier shall promptly notify the Purchaser in writing of such condition and the cause thereof. Unless otherwise directed by the Purchaser in writing, the Supplier shall continue to perform its obligations under the Contract as far as is reasonably practical, and shall seek all reasonable alternative means for performance not prevented by the Force Majeure event.</p>
<p><b>Change Orders and Contract Amendments</b></p>	<p>32. Change Orders and Contract Amendments</p>	<p>32.1 The Purchaser may at any time order the Supplier through notice in accordance CC Clause 8, to make changes within the general scope of the Contract in any one or more of the following:</p> <ul style="list-style-type: none"> <li>(a) drawings, designs, or specifications, where Goods to be furnished under the Contract are to be specifically manufactured for the Purchaser;</li> <li>(b) the method of shipment or packing;</li> <li>(c) the place of delivery; and</li> <li>(d) the Related Services to be provided by the Supplier.</li> </ul> <p>32.2 If any such change causes an increase or decrease in the cost of, or the time required for, the Supplier’s performance of any provisions under the Contract, an equitable adjustment shall be made in the Contract Price or in the Delivery/Completion Schedule, or both, and the Contract shall accordingly be amended. Any claims by the Supplier for adjustment under this Clause must be asserted within twenty-eight (28) days from the date of the Supplier’s receipt of the Purchaser’s change order.</p> <p>32.3 Prices to be charged by the Supplier for any Related Services that might be needed but which were not included in the Contract shall be agreed upon in advance by the parties and shall not exceed the prevailing rates charged to other parties by the Supplier for similar services.</p>

		32.4 Subject to the above, no variation in or modification of the terms of the Contract shall be made except by written amendment signed by the parties.
<b>Extensions of Time</b>	33. Extensions of Time	<p>33.1 If at any time during performance of the Contract, the Supplier or its subcontractors should encounter conditions impeding timely delivery of the Goods or completion of Related Services pursuant to CC Clause 12, the Supplier shall promptly notify the Purchaser in writing of the delay, its likely duration, and its cause. As soon as practicable after receipt of the Supplier's notice, the Purchaser shall evaluate the situation and may at its discretion extend the Supplier's time for performance, in which case the extension shall be ratified by the parties by amendment of the Contract.</p> <p>33.2 Except in case of Force Majeure, as provided under CC Clause 31, a delay by the Supplier in the performance of its Delivery and Completion obligations shall render the Supplier liable to the imposition of liquidated damages pursuant to CC Clause 26, unless an extension of time is agreed upon, pursuant to CC Sub-Clause 33.1.</p>
<b>Termination</b>	34. Termination	<p>34.1 Termination for Default:</p> <p>(a) The Purchaser, without prejudice to any other remedy for breach of Contract, by written notice of default sent to the Supplier, may terminate the Contract in whole or in part:</p> <p>(i) if the Supplier fails to deliver any or all of the Goods within the period specified in the Contract, or within any extension thereof granted by the Purchaser pursuant to CC Clause 33;</p> <p>(ii) if the Supplier fails to perform any other obligation under the Contract; or</p> <p>(iii) if the Supplier, in the judgment of the Purchaser has engaged in fraud and corruption, as defined in CC Clause 3, in competing for or in executing the Contract.</p> <p>(b) In the event the Purchaser terminates the Contract in whole or in part, pursuant to CC Clause 34.1(a), the Purchaser may procure, upon such terms and in such manner as it deems appropriate, Goods or Related Services similar to those undelivered or not performed, and the Supplier shall be liable to the Purchaser for any additional costs for such similar Goods or Related Services. However, the Supplier shall</p>

		<p>continue performance of the Contract to the extent not terminated.</p> <p>34.2 Termination for Insolvency:  (a) The Purchaser may at any time terminate the Contract by giving notice to the Supplier if the Supplier becomes bankrupt or otherwise insolvent. In such event, termination will be without compensation to the Supplier, provided that such termination will not prejudice or affect any right of action or remedy that has accrued or will accrue thereafter to the Purchaser.</p> <p>34.3 Termination for Convenience:  (a) The Purchaser, by notice sent to the Supplier, may terminate the Contract, in whole or in part, at any time for its convenience. The notice of termination shall specify that termination is for the Purchaser's convenience, the extent to which performance of the Supplier under the Contract is terminated, and the date upon which such termination becomes effective.  (b) The Goods that are complete and ready for shipment within twenty-eight (28) days after the Supplier's receipt of notice of termination shall be accepted by the Purchaser at the Contract terms and prices. For the remaining Goods, the Purchaser may elect:  (i) to have any portion completed and delivered at the Contract terms and prices; and/or  (ii) to cancel the remainder and pay to the Supplier an agreed amount for partially completed Goods and Related Services and for materials and parts previously procured by the Supplier.</p>
<b>Assignment</b>	35. Assignment	35.1 Neither the Purchaser nor the Supplier shall assign, in whole or in part, their

## SECTION VII

### CONTRACT DATA

The following Contract Data shall supplement and/or amend the Conditions of Contract (CC). Whenever there is a conflict, the provisions herein shall prevail over those in the CC.

CLAUSE	GENERAL
CC 1.1(i)	The Purchaser is Sri Lanka Air Force.
CC 1.1(m)	The Project Site(s)/Final Destination(s) is/are
CC 8.1	For notices, the Purchaser's address shall be: Chief Procurement Officer Air Force Headquarters P.O Box 594, Defence Headquarters Complex Sri Jayewardenepura, Kotte Sri Lanka. <b>Tel:</b> +94 112 328850/ 2441553 <b>E-mail:</b> <a href="mailto:acpot@slaf.gov.lk">acpot@slaf.gov.lk</a>
CC 12.1	Details of Shipping and other Documents to be furnished by the Supplier are For Local Contract i. Original Invoice (This should be prepared in accordance with the details given in the SLAF Order Form – Any disparity between the order form and your invoice may cause rejection of your invoice and delays in the payment process) ii. A copy of the SLAF Order Form iii. Duly Completed and signed F 666 s (F 666 is an SLAF document that must be submitted along with your invoice) iv. SLAF Convoy Note (this should be collected from Collection and Clearance Section AFHQ SJP on Tel. 0112-441044 – Ext. 12936). v. Any other document such as Warranty Cards, Manuals etc which are required for acceptance of the goods.
CC 15.1	The method and conditions of payment to be made to the Supplier under this Contract shall be as follows: <b>A: For Goods offered within Sri Lanka</b> Payments shall be made <b>in Sri Lanka Rupees</b> not later than Forty (45) working days after submission of the invoice along with duly completed F 666s and copy of the SLAF Order Form and after the SLAF has accepted it, whichever occurs later.

As stated above, the following documents are required for the payment:

- i. Original Invoice (This should be prepared in accordance with the details given in the SLAF Order Form)
- ii. A copy of SLAF Order Form
- iii. Duly Completed and signed F 666 s (F 666 is an SLAF document that must be submitted along with your invoice)
- iv. Warranty Certificate (if applicable)

No advance payment will be paid by the SLAF.

**B: For Goods offered in Foreign Currency**

The payment may be effected **on approved foreign currency** on **LETTER OF CREDIT** basis as required, which is paid on 40% (on presentation of documents) 60% (on receipt and acceptance) basis for the payment of total invoice value. SELLERS are to note that no advance payments will be effected.

If any local SELLER becomes eligible to supply the component(s)/item(s) the payments will be settled after acceptance of component(s)/item(s) to Sri Lanka Air Force. The SLAF will not effect the advance payment or Local Letter of Credit and if any bidder request to establish a Local Letter of Credit will be a disqualification.

The LETTER OF CREDIT for the value of the total cost of the component(s)/item(s) is to be established by the SERVICE RECIPIENT in a form of an irrevocable unconfirmed at sight Letter of Credit opened in favour of the SELLER. The Letter of Credit shall be issued by People's Bank, and established with the agents of the People's Bank in the country of the SELLER and advised through SELLER's bank nominated by the SELLER. If confirmation insisted by the SELLER, Confirmation charges shall be at the SELLER's cost.

**40%** of the total cost of the component(s)/item(s) shall be paid to the SELLER at sight upon presentation of the following documents (in English Language) stipulated under the LETTER OF CREDIT and provided that the documents so prescribed are in conformity with this Contract.



	<p>a. Commercial Invoice in Three (3) Originals for the amount of <b>40%</b> value of the total cost of the item(s) /component(s).</p> <p>b. Clean Bill of Lading/Airway Bill.</p> <p>c. Packing List.</p> <p>d. Insurance certificates</p> <p>e. Certificate of Compliances (<i>if applicable</i>).</p> <p>f. Certificate of Country of origin</p> <p>g. Warranty Certificate (<i>if applicable</i>).</p> <p>60% of the total cost of the component(s)/item(s) shall be paid to the SELLER after completion of the final acceptance in Sri Lanka at Sri Lanka Air Force Base Katunayake and upon presentation of the following documents stipulated under the LETTER OF CREDIT including Certificate of Acceptance issued by the SLAF.</p> <p>a. Commercial Invoice in Three (3) Originals for the amount of <b>60%</b> value of the total cost of the item(s) /component(s).</p> <p>b. Final Acceptance Certificate signed and issued by the Sri Lanka Air Force</p>
<b>CC 17.1</b>	A Performance Security shall be (10%) of the contract value.
<b>CC 25.1</b>	The inspections and tests shall be <b><i>“Bidders are required to provide physical samples that fully comply with the specified requirements. Samples must be clearly labelled for easy identification, including the Bidder’s name, Tender reference, and corresponding item number. Bids submitted without the required samples will be rejected. Further, a non-refundable sample testing fee of Rs. 100,000.00 shall be deposited. The original receipt issued by the Director Finance of SLAF must be attached to the original bid and presented at the time of bid opening. Further, during the bulk delivery a random sample from each bulk delivery will be tested by an institute nominated by the SLAF, with the testing costs to be borne by the bidder. ”</i></b>
<b>CC 25.2</b>	The inspections and tests shall be conducted upon receipt of Goods at Sri Lanka Air Force Base Katunayake.
<b>CC 26.1</b>	<b>In the event that the Supplier/Service Provider fails to deliver the goods within the agreed delivery schedule, the Supplier/Service Provider shall be liable to pay liquidated damages to the Sri Lanka Air Force (SLAF) at a rate of 1% of the total contract value per week (or part thereof) for each week</b>

	<p>of delay. The total liquidated damages payable under this clause shall not exceed <b>10% of the total contract value</b>. Should the accumulated liquidated damages reach the maximum limit of <b>10%</b>, SLAF reserves the right to terminate the contract and seek alternative suppliers without further notice. In the event of delayed payments by SLAF, the Supplier or Service Provider shall be entitled to an offset reflecting the actual financial loss or opportunity cost incurred, calculated based on the Sri Lanka Average Weighted Prime Lending Rate (Weekly AWPR) applicable at the time of the delay calculation.</p>
<b>CC 26.1</b>	The maximum amount of liquidated damages shall be 10%.

# SECTION IX

## CONTRACT FORMS

### 1. Contract Agreement

THIS CONTRACT AGREEMENT is made the [insert: number] day of [insert: month], [insert: year].

#### **BETWEEN**

(1) [insert complete name of Purchaser], a [insert description of type of legal entity, for example, an agency of the Ministry of ..... or corporation and having its principal place of business at [insert address of Purchaser] (hereinafter called “the Purchaser”), and

(2) [insert name of Supplier], a corporation incorporated under the laws of [insert: country of Supplier] and having its principal place of business at [insert: address of Supplier] (hereinafter called “the Supplier”).

**WHEREAS** the Purchaser invited bids for certain Goods and ancillary services, viz., [insert brief description of Goods and Services] and has accepted a Bid by the Supplier for the supply of those Goods and Services in the sum of [insert Contract Price in words and figures, expressed in the Contract currency(ies)] (hereinafter called “the Contract Price”).

#### **NOW THIS AGREEMENT WITNESSETH AS FOLLOWS:**

1. In this Agreement, words and expressions shall have the same meanings as are respectively assigned to them in the Conditions of Contract referred to.
2. The following documents shall constitute the Contract between the Purchaser and the Supplier, and each shall be read and construed as an integral part of the Contract:
  - (a) This Contract Agreement
  - (b) Contract Data
  - (c) Conditions of Contract
  - (d) Technical Requirements (including Schedule of Requirements and Technical Specifications)
  - (e) The Supplier’s Bid and original Price Schedules
  - (f) The Purchaser’s Notification of Award
  - (g) [Add here any other document(s)]
3. This Contract shall prevail over all other Contract documents. In the event of any discrepancy or inconsistency within the Contract documents, then the documents shall prevail in the order listed above.
4. In consideration of the payments to be made by the Purchaser to the Supplier as hereinafter mentioned, the Supplier hereby covenants with the Purchaser to provide the Goods and Services and to remedy defects therein in conformity in all respects with the provisions of the Contract.

5. The Purchaser hereby covenants to pay the Supplier in consideration of the provision of the Goods and Services and the remedying of defects therein, the Contract Price or such other sum as may become payable under the provisions of the Contract at the times and in the manner prescribed by the Contract.

**IN WITNESS** whereof the parties hereto have caused this Agreement to be executed in accordance with the laws of the Democratic Socialist Republic of Sri Lanka on the day, month, and year indicated above.

**For and on behalf of the Purchaser**

Signed: [insert signature] in the capacity of [insert title or other appropriate designation] in the presence of [insert identification of official witness]

**For and on behalf of the Supplier**

Signed: [insert signature of authorized representative(s) of the Supplier] in the capacity of [insert title or other appropriate designation] in the presence of [insert identification of official witness]

## 2. PERFORMANCE SECURITY

[Note: the purchaser is required to fill the information marked as “\*” and delete this note prior to selling of the bidding document]

[The issuing agency, as requested by the successful Bidder, shall fill in this form in accordance with the instructions indicated]

--- [Issuing Agency’s Name, and Address of Issuing Branch or Office] ---

Beneficiary: **Commander of the Sri Lanka Air Force, Air Force Headquarters, P.O Box 594, Defence Headquarters Complex, Sri Jayewardenepura, Kotte, Sri Lanka**

Date: ---

### **PERFORMANCE GUARANTEE No.: ---**

We have been informed that --- [name of Supplier] (hereinafter called "the Supplier") has entered into Contract No. --- [reference number of the contract] dated --- with you, for the Purchase of Medal with Ribbon for awarding the Commemorative Medal on the 75<sup>th</sup> Anniversary of the SLAF for S&MD stock (hereinafter called "the Contract"). Furthermore, we understand that, according to the conditions of the Contract, a performance guarantee is required.

At the request of the Supplier, we --- [name of Agency] hereby irrevocably undertake to pay you any sum or sums not exceeding in total an amount of --- [amount in figures] (----) [amount in words], such sum being payable in the types and proportions of currencies in which the Contract Price is payable, upon receipt by us of your first demand in writing accompanied by a written statement stating that the Contractor is in breach of its obligation(s) under the Contract, without your needing to prove or to show grounds for your demand or the sum specified therein.

This guarantee shall expire, no later than the ... day of ....., 2025.. [insert date, 28 days beyond the scheduled completion date including the warranty period], and any demand for payment under it must be received by us at this office on or before that date.

[signature(s)]

**INVITATION FOR BIDS**



**SRI LANKA AIR FORCE**

1. The Chairman, Department Procurement Committee (DPC) of the Sri Lanka Air Force (SLAF), invites sealed bids for following tenders:

S/No	Procurement Identification Number	Tender Description	Pre Bid Meeting	Bid Security Validity Period and Value	Last Date of Issuing of Bidding Documents	Non Refundable Fee (Rs.)	Bid Closing / Opening	Procurement Method
01	AHQ/25/FS/CLO/1004	Purchase of Medal with Ribbon for awarding the Commemorative Medal on the 75th Anniversary of the SLAF	23 April 2025 at 1000 hrs	03 October 2025 Rs.1,634,713.00	29 May 2025	35,000.00	30 May 2025 at 1030 hrs	<b>ICB</b>
02	AHQ/25/FS/BHK/1003	Purchase of P/No HC-B4MP-3C Propeller Assy for King Air KA 360ER and KA350 Aircraft	23 April 2025 at 1000 hrs	03 October 2025 Rs.300,000.00	29 May 2025	3,500.00	30 May 2025 at 1030 hrs	<b>ICB</b>
03	AHQ/24/PUB/CLO/1019	Purchase of Jogging Shoes for Airmen and Airwomen (JNCO's and below ranks)	23 April 2025 at 1030 hrs	05 September 2025 Rs.1,033,600.00	08 May 2025	20,000.00	09 May 2025 at 1030 hrs	<b>NCB</b>
04	AHQ/25/PUB/E/1002	Hiring of Qty 53 Cars (Sedan) to Sri Lanka Air Force	23 April 2025 at 1030 hrs	05 September 2025 Rs.1,526,400.00	08 May 2025	35,000.00	09 May 2025 at 1030 hrs	<b>NCB</b>
05	AHQ/24/PUB/E/1024	Hiring of Qty 35 Cars (Sedan) to Sri Lanka Air Force	23 April 2025 at 1030 hrs	05 September 2025 Rs.1,008,000.00	08 May 2025	20,000.00	09 May 2025 at 1030 hrs	<b>NCB</b>
06	AHQ/25/PUB/V&A/1001	Purchase of Personal Computers (Core I3) for SLAF requirement	23 April 2025 at 1100 hrs	05 September 2025 Rs.350,000.00	08 May 2025	12,500.00	09 May 2025 at 1030 hrs	<b>NCB</b>
07	AHQ/25/PUB/V&A/1002	Purchase of Hyper Converged Infrastructure (HCI) Cluster for SLAF Data Network	23 April 2025 at 1100 hrs	05 September 2025 Rs.270,000.00	08 May 2025	3,500.00	09 May 2025 at 1030 hrs	<b>NCB</b>
08	AHQ/25/PUB/B&CE/1002	Purchase of Asphalt Concrete (Wearing Course) for Development of Hingurakgoda Airport Project (Stage - IV)	23 April 2025 at 1130 hrs	05 September 2025 Rs.944,590.00	08 May 2025	20,000.00	09 May 2025 at 1030 hrs	<b>NCB</b>
09	AHQ/25/PUB/B&CE/1003	Purchase of Asphalt Concrete (Binder Course) for Development of Hingurakgoda Airport Project (Stage - IV)	23 April 2025 at 1130 hrs	05 September 2025 Rs.877,448.00	08 May 2025	20,000.00	09 May 2025 at 1030 hrs	<b>NCB</b>

